



# POWER E SERVICE

## POWER & SERVICE

ACCESSORI PER BATTERIA ED ELETTRICI AVVIATORI  
ILLUMINAZIONE DA LAVORO BATTERIE TUBI PER FLUIDI  
INGRASSATORI MINUTERIE ARIA COMPRESSA LAVAMANI  
GUANTI MONOUSO E TESSUTO LIQUIDI TECNICI

2022 - 2023

[www.viviautoparts.it](http://www.viviautoparts.it)



**PRESENTAZIONE**  
**PRESENTATION** **4**

**BATTERIE AUTO & TRUCK**  
**BATTERIES AUTO & TRUCK** **5**

**AVVIATORI MANUTENTORI INVERTITORI**  
**JUMP STARTER INTELLIGENT CHARGER**  
**INVERTER** **17**

**ACCESSORI PER BATTERIA**  
**BATTERY EQUIPMENT** **26**

**ACCESSORI ELETTRICI**  
**ELECTRIC EQUIPMENT** **31**

**ILLUMINAZIONE DA LAVORO**  
**WORKING LIGHT** **43**

**MINUTERIE**  
**SMALL PARTS** **56**

**TUBI PER FLUIDI**  
**FLUIDS HOSES** **64**

**INGRASSATORI E ACCESSORI**  
**GREASE ELEMENTS** **67**

Azienda/Company \_\_\_\_\_ 4  
Produzione/Production \_\_\_\_\_ 4

Premium AGM \_\_\_\_\_ 7  
Supreme AFB \_\_\_\_\_ 9  
Power Tech \_\_\_\_\_ 11  
Japan Tech \_\_\_\_\_ 13  
Truck Tech \_\_\_\_\_ 15  
Schemi / Diagrams \_\_\_\_\_ 87

Avviatore a batteria 3000A / Battery Jump Starter 3000A \_\_\_\_\_ 18  
Avviatore litio 2800A / Lithium Jump Starter 2800A \_\_\_\_\_ 19  
Avviatore litio 800A / Lithium Jump Starter 800A \_\_\_\_\_ 20  
Avviatore litio 400A / Lithium Jump Starter 400A \_\_\_\_\_ 21  
Manutettore 15A / Intelligent charger 15A \_\_\_\_\_ 22  
Manutettore 8A / Intelligent charger 8A \_\_\_\_\_ 23  
Manutettore 4A / Intelligent charger 4A \_\_\_\_\_ 23  
Manutettore 1A / Intelligent charger 1A \_\_\_\_\_ 24  
Invertitori / Inverter \_\_\_\_\_ 25

Cavi di Avviamento / Boost cable \_\_\_\_\_ 27  
Pinze Batteria / Battery clamps \_\_\_\_\_ 27  
Morsetti Batteria / Terminal Battery \_\_\_\_\_ 28  
Accessori batteria / Battery accessory \_\_\_\_\_ 29  
Staccabatteria / Battery switch \_\_\_\_\_ 29  
Relé Batteria / Battery relays \_\_\_\_\_ 30

Spine Carrello / Socket trail \_\_\_\_\_ 32  
Connettori lampade / Socket lamp \_\_\_\_\_ 33  
Accendisigari / Cigarette lighter \_\_\_\_\_ 33  
Pulsanti / Car switches \_\_\_\_\_ 34  
Terminali capicorda / Terminals \_\_\_\_\_ 35  
Fusibili a lama e cilindrici / Blade & cylinder fuses \_\_\_\_\_ 37  
Fusibili pal / Pal fuses \_\_\_\_\_ 38  
Fusibili Pal-J case / Pal-Jcase fuses \_\_\_\_\_ 39  
Fusibili Midi & Mega / Midi & Mega fuses \_\_\_\_\_ 40  
Portafusibili / Fuse holder \_\_\_\_\_ 41  
Clacson / Disc horn \_\_\_\_\_ 42

Rotanti Led Alogeno / Rotating beacon \_\_\_\_\_ 44  
Visibilità / Visibility light \_\_\_\_\_ 45  
Luci emergenza / Emergency light \_\_\_\_\_ 46  
Barre led emergenza / Led warning bar \_\_\_\_\_ 47  
Luci ingombro / Cluttered light \_\_\_\_\_ 48  
Catarinfrangenti / Reflector light \_\_\_\_\_ 48  
Luci targa / Plate light \_\_\_\_\_ 50  
Luci carrello / Trail light \_\_\_\_\_ 50  
Torce led / Led torches \_\_\_\_\_ 51

Fascette in metallo / Metal ties \_\_\_\_\_ 57  
Fascette in nylon / Nylon cable ties \_\_\_\_\_ 59  
Rondelle / Washers \_\_\_\_\_ 60

Tubi carburante inserto tessuto interno / Fuel hoses inner textile \_\_\_\_\_ 65  
Tubi carburante treccia tessuto esterna / Fuel hoses external textile \_\_\_\_\_ 65  
Tubi acqua / Water hoses \_\_\_\_\_ 66  
Tubi PVC / PVC hoses \_\_\_\_\_ 66

Ingrassatori, testine e accessori / Grease, head and accessory \_\_\_\_\_ 68

**ARIA COMPRESSA & GONFIATORI**  
**COMPRESSED AIR & INFLATORS** **70**

Pistole e accessori / *Guns and accessories* ..... 71  
Gonfia e ripara gomme / *Tyre inflator* ..... 71

**PILE DURACELL**  
**DURACELL BATTERIES** **72**

Pile e batterie / *Cells and batteries* ..... 73

**PRODOTTI SERVICE**  
**SERVICE PRODUCTS** **75**

Bobine di carta / *Paper reels* ..... 76  
Prodotti lavamani / *Hand washing* ..... 76  
Guanti monouso / *Disposable gloves* ..... 77  
Guanti tessuto / *Fabric gloves* ..... 78  
Nastri adesivi / *Adhesive tapes* ..... 80

**LIQUIDI TECNICI**  
**TECHNICAL FLUIDS** **83**

Antigelo motore / *Antifreezing* ..... 84  
Chimico parabrezza / *Chemical windshield* ..... 85  
Liquidi freni / *Brake fluids* ..... 86  
ADBlue ..... 86

# AZIENDA & PRODUZIONE

---

## COMPANY & PRODUCTION



 VIVI srl è una realtà internazionale che opera nel settore ricambi auto aftermarket dal 1966 con la ditta Accessauto. Produciamo e commercializziamo con passione prodotti innovativi con il marchio VIVI AUTOPARTS nei campi che più rappresentano la nostra professionalità e le nostre competenze come spazzole tergicristallo, lampade e illuminazione, catene da neve, avviatori e manutentori per batteria, accessori elettrici, guanti da lavoro e sistemi di portaggio. Le sfide del mercato rappresentano per noi l'occasione di una continua attività di ricerca e sviluppo che ci porta ad ampliare costantemente la nostra offerta in termini di qualità e completezza del prodotto. Da più di 50 anni infatti ci atteniamo con dedizione e serietà a precisi standard di prodotto che un mercato dinamico, come quello dei ricambi auto, ci riconosce anno dopo anno: qualità, semplicità, completezza e organizzazione sono i concetti che guidano ogni nostro passo.

 VIVI Srl is an international Company working on automotive aftermarket's trade since 1966 by the historical Company Accessauto. Under its own brand VIVI AUTOPARTS, it produces and sales all over the Europe market several car spare parts and accessories unique for technological innovation and quality. Thanks to its experience and continue research in automotive's field. Vivi develops many products as wiper blade, bulbs and lighting, snow chain, work gloves, power (battery starter and power) accessories and portable systems. The most important values are quality, easy, full range, logistic, marketing and communication.

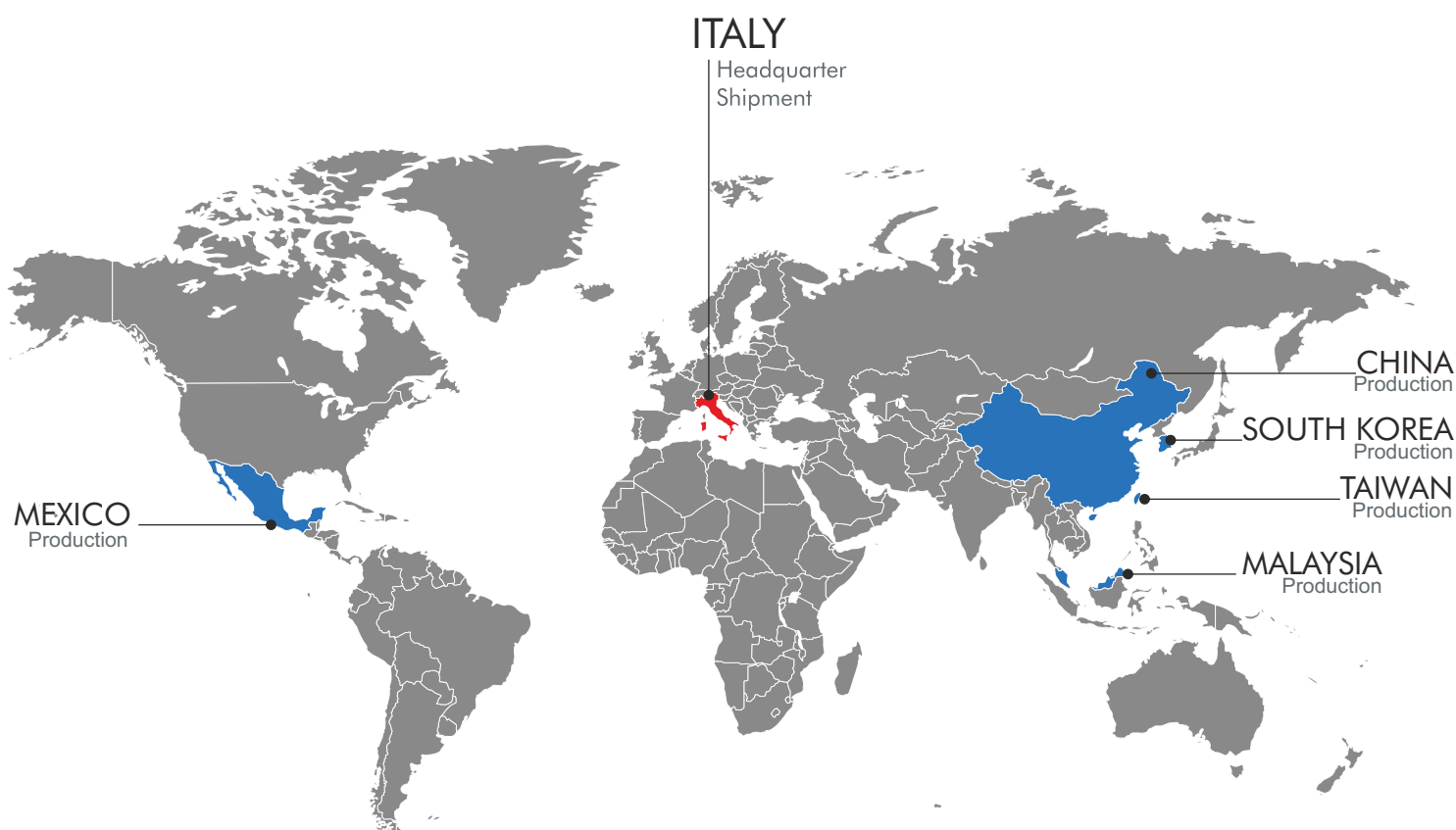





# BATTERIE AUTO & TRUCK

AUTO & TRUCK BATTERY



**SUPREMA**

ANNO 1 2 3 4 5  
YEAR 6 7 8 9 0  
MESE 1 2 3 4 5 6  
MONTH 7 8 9 10 11 12



# PREMIUM AGM 12V

## 12V AGM BATTERIES

Tecnologia AGM acronimo di ABSORBENT GLASS MATERIAL batterie che offrono rendimenti ottimali operando in condizioni di estremo ciclaggio; ideali per i modelli di auto Micro Ibride con dispositivi START&STOP, BRAKE ENERGY REGENERATION e tutte le altre tecnologie legate al risparmio dei consumi.

AGM technology acronym for ABSORBENT GLASS MATERIAL batteries that offer optimal performance by operating in conditions of extreme cycling; ideal for Micro Hybrid car models with START & STOP, BRAKE ENERGY REGENERATION devices and all other technologies related to energy saving.

VALVOLE DI SICUREZZA

VALVES OF SAFETY



MONOBLOCCO IN POLIPROPILENE

POLYPROPYLENE MONOBLOCK

SEPARATORI DI MICROFIBRA IN VETRO

SEPARATORS OF GLASS MICROFIBER

## AGM: COME FUNZIONA? AGM: HOW DOES IT WORKS?

**ITA** Una batteria **PREMIUM AGM VIVI Autoparts** sfrutta il principio della ricombinazione ovvero: grazie alla presenza di un separatore microporoso impregnato con una certa quantità di elettrolita, l'ossigeno liberato dalla piastra positiva durante la fase di ricarica (in seguito alla dissociazione dell'acqua) è in grado di migrare verso la piastra negativa da cui viene fissato per ricombinarsi con l'idrogeno ripristinando l'acqua.

In questo modo all'interno della batteria si instaura un ciclo elettrochimico chiuso che non produce alcuna emissione di gas e non consuma acqua. L'AGM, data la sua semplicità, richiede estrema precisione costruttiva dei componenti ed utilizzo di materiali di altissima qualità, tutto questo è ciò che caratterizza le batterie PREMIUM AGM di VIVI Autoparts.

**EN** A **PREMIUM AGM VIVI Autoparts** battery uses the principle of recombination, that is: thanks to the presence of a microporous separator impregnated with a certain amount of electrolyte, the oxygen released by the positive plate during the recharging phase (following the dissociation of the water) is able to migrate to the negative plate from which it is fixed to recombine with hydrogen restoring the water. In this way, a closed electrochemical cycle is established inside the battery which does not produce any gas emissions and does not consume water. AGM, given its simplicity, requires extreme construction precision of the components and the use of the highest quality materials, all of this is what characterizes VIVI Autoparts PREMIUM AGM batteries.



## CARATTERISTICHE *FEATURES*

<b>QUALITÀ OE</b> <i>OE QUALITY</i>	_____
<b>SENZA MANUTENZIONE</b> <i>NO MAINTENANCE</i>	_____
<b>AUTOSCARICA MINIMA</b> <i>MINIMUM SELF-DISCHARGE</i>	_____
<b>ELEVATA RESISTENZA ALLE VIBRAZIONI</b> <i>HIGH RESISTANCE TO VIBRATIONS</i>	_____
<b>NESSUNA FUORIUSCITA DI LIQUIDI O GAS</b> <i>NO LIQUID OR GAS LEAKAGE</i>	_____
<b>CORRENTE DI SPUNTO MASSIMA</b> <i>MAX INPUT CURRENT</i>	_____
<b>3xRESISTENZA AI CICLI DI CARICA E SCARICA</b> <i>(3 VOLTE IN PIÙ RISPETTO ALLE BATTERIE PIOMBO-CALCIO)</i> <i>3xRESISTANCE TO CHARGE AND DISCHARGE CYCLES</i> <i>(3 TIMES MORE THAN LEAD-CALCIUM BATTERIES)</i>	_____



## GAMMA PREMIUM AGM *PREMIUM AGM RANGE*

CODICE ARTICOLO	CODICE INTERNO	GRUPPO DIMENSIONALE	CAPACITA' Ah	A EN	DIMENSIONI L x P x H (mm)	POLARITA'	FISSAGGIO ALLA BASE
<b>PREMIUM AGM BATTERY 12V</b>							
<b>AGM6000680</b>	002143	L2 AGM	60	680	242X175X190	DX(0/1)	B13
<b>AGM7000760</b>	002144	L3 AGM	70	760	278X175X190	DX(0/1)	B13
<b>AGM8000800</b>	002145	L4 AGM	80	800	315X175X190	DX(0/1)	B13
<b>AGM9500850</b>	002146	L5 AGM	95	850	353X175X190	DX(0/1)	B13
<b>AGM1050950</b>	002147	L6 AGM	105	950	394X175X190	DX(0/1)	B13

\*Schemi consultabili a pag. 87

**ITA** E' altamente sconsigliato e pericoloso l'impiego delle batterie tradizionali ad acido libero per i veicoli micro ibridi. VIVI raccomanda l'installazione di batterie AFB/AGM per suddetti modelli. In caso di sostituzione è necessario rispettare sempre la tecnologia della batteria originale.

**EN** The use of traditional free acid batteries for micro hybrid vehicles is highly discouraged and dangerous. VIVI recommends the installation of AFB / AGM batteries for these models. In the event of replacement, the original battery technology must always be respected.

## ATTENZIONE *ATTENTION*

# SUPREME AFB 12V

## 12V AFB BATTERIES

Tecnologia AFB acronimo di ADVANCED FLOODED BATTERY batterie caratterizzate da una resistenza al ciclaggio 2 volte superiore rispetto a una batteria tradizionale. In fase di Start&Stop fornisce energia costante a tutti i componenti elettrici assicurando la ripartenza. Ideali per i modelli di auto del segmento medio dotate di sistema START&STOP.

AFB technology acronym for ADVANCED FLOODED BATTERY batteries characterized by a cycling resistance 2 times higher than a traditional battery. During the Start & Stop phase, it supplies constant energy to all the electrical components, ensuring restart. Ideal for mid-range car models equipped with the START & STOP system.

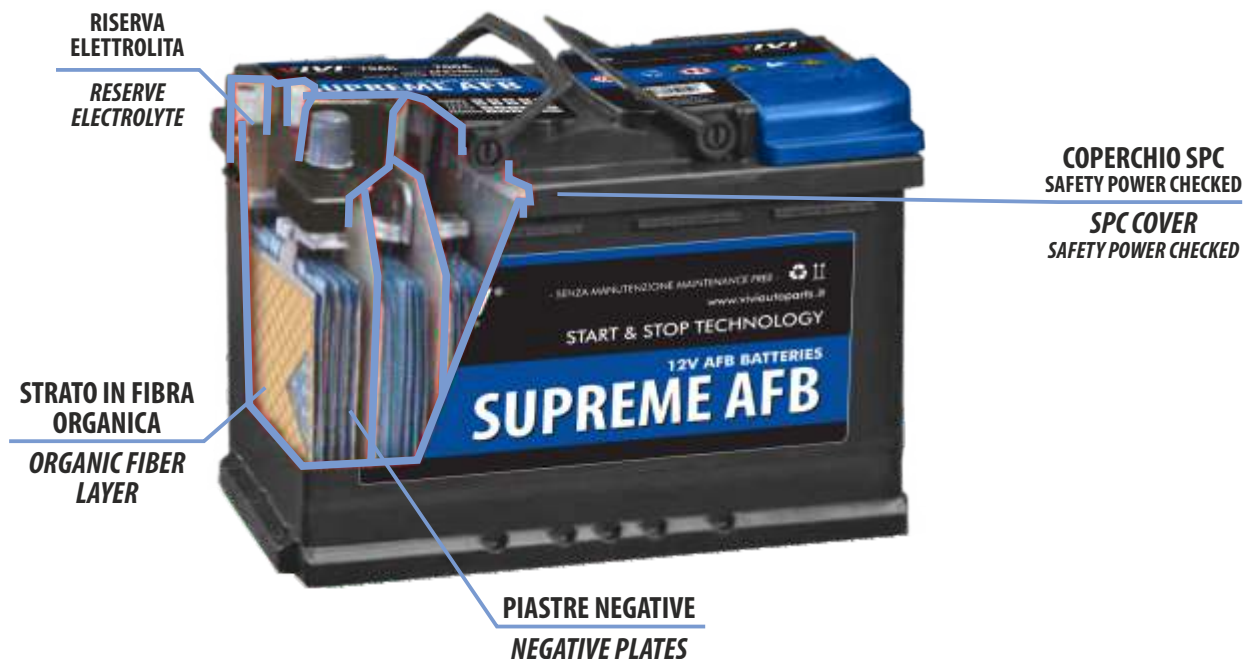

## AFB: COME FUNZIONA? AGM: HOW DOES IT WORKS?

**ITA** La batteria **SUPREME AFB VIVI Autoparts** rappresenta un'evoluzione rispetto alle tradizionali per alcune caratteristiche costruttive importanti:

maggior riserva di elettrolita; piastre negative formate da: griglia in lega Piombo-Calcio-Stagno, composizione massa attiva negativa a carbonio maggiorato, miscela di espansori concepita ad hoc per supportare i cicli Start&Stop, fibra organica che contiene l'espansione della massa attiva durante il ciclaggio; separazione doppia tra piastre positive e negative; protezione delle bandiere degli elettrodi dalla corrosione e dalle situazioni di pericolo potenziali.

**EN** The **SUPREME AFB VIVI Autoparts** battery represents an evolution compared to the traditional ones for some important construction features: greater electrolyte reserve; negative plates formed by: Lead-Calcium-Tin alloy grid, composition of negative active mass with increased carbon, mixture of expanders designed specifically to support Start & Stop cycles, organic fiber that contains the expansion of the active mass during cycling; double separation between positive and negative plates; protection of the flags of the electrodes from corrosion and from potentially dangerous situations.

## CARATTERISTICHE FEATURES

**QUALITÀ OE OE QUALITY** \_\_\_\_\_

**SENZA MANUTENZIONE NO MAINTENANCE** \_\_\_\_\_

**GRANDE POTENZA DI AVVIAMENTO** \_\_\_\_\_  
*GREAT STARTING POWER*

**CICLO DI VITA PIÙ LUNGO LONGER LIFE CYCLE** \_\_\_\_\_  
 (RISPETTO ALLE BATTERIE TRADIZIONALI)

**MASSA ATTIVA NEGATIVA CONCEPITA PER** \_\_\_\_\_  
**I CICLI START&STOP**  
*CONCEIVED NEGATIVE ACTIVE MASS FOR*  
*START & STOP CYCLES*

**ELEVATA RESISTENZA AI CICLI DI CARICA E SCARICA** \_\_\_\_\_  
 (RISPETTO ALLE BATTERIE PIOMBO-CALCIO)  
*HIGH RESISTANCE TO CHARGE AND DISCHARGE CYCLES*



## GAMMA SUPREME AFB SUPREME AFB RANGE

CODICE ARTICOLO	CODICE INTERNO	GRUPPO DIMENSIONALE	CAPACITA' Ah	A EN	DIMENSIONI L x P x H (mm)	POLARITA'	FISSAGGIO ALLA BASE
<b>SUPREME AFB BATTERY 12V</b>							
<b>AFB6000520</b>	002148	L2 AFB	60	520	242X175X190	DX(0/1)	B13
<b>AFB70B0650</b>	002149	L3B AFB	70	650	278X175X175	DX(0/1)	B13
<b>AFB7000700</b>	002150	L3 AFB	70	700	278X175X190	DX(0/1)	B13
<b>AFB8000740</b>	002189	L4	80	740	315X175X190	DX(0/1)	B13
<b>AFB9500850</b>	002190	L5	95	850	353X175X190	DX(0/1)	B13

\*Schemi consultabili a pag. 87

**ITA** E' altamente sconsigliato e pericoloso l'impiego delle batterie tradizionali ad acido libero per i veicoli micro ibridi. VIVI raccomanda l'installazione di batterie AFB/AGM per suddetti modelli. In caso di sostituzione è necessario rispettare sempre la tecnologia della batteria originale.

**EN** The use of traditional free acid batteries for micro hybrid vehicles is highly discouraged and dangerous. VIVI recommends the installation of AFB / AGM batteries for these models. In the event of replacement, the original battery technology must always be respected.

## ATTENZIONE ATTENTION

# POWER TECH 12V 12V SLI BATTERIES



## BATTERIE 12V AUTO 12V CAR BATTERY

**ITA** La batteria **POWER TECH VIVI Autoparts** è studiata e progettata per soddisfare qualsiasi esigenza; grazie ad elevate prestazioni ed ottimali caratteristiche tecniche e costruttive che permettono di coprire il 95% del parco auto circolante in Europa. La batteria **POWER TECH VIVI Autoparts** garantisce massima affidabilità di avviamento grazie ai processi produttivi impiegati e alla qualità dei componenti.

**EN** The **POWER TECH VIVI Autoparts** battery is studied and designed to satisfy any need; thanks to high performance and excellent technical and construction characteristics that make it possible to cover 95% of the car fleet in circulation in Europe. The **POWER TECH VIVI Autoparts** battery guarantees maximum starting reliability thanks to the production processes used and the quality of the components.



# CARATTERISTICHE *FEATURES*

**QUALITÀ OE** *OE QUALITY* \_\_\_\_\_

**SENZA MANUTENZIONE** *NO MAINTENANCE* \_\_\_\_\_

**AFFIDABILITÀ DI AVVIAMENTO** \_\_\_\_\_  
*START-UP RELIABILITY*

**SICUREZZA NEL COPERCHIO** *SAFETY IN THE COVER* \_\_\_\_\_  
(SISTEMA FUORIUSCITA DEI GAS AIUTA A PRESERVARE I COMPONENTI  
DEL VANO MOTORE DALLA CORROSIONE)  
(*GAS RELEASE SYSTEM HELPS TO PRESERVE THE COMPONENTS OF  
THE ENGINE COMPARTMENT FROM CORROSION*)

**PRATICITÀ E FUNZIONALITÀ** \_\_\_\_\_  
*CONVENIENCE AND FUNCTIONALITY*

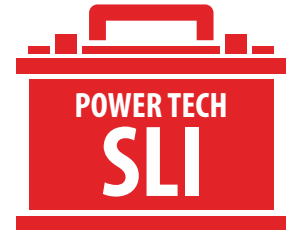

## GAMMA STANDARD AUTO *STANDARD CAR RANGE*

CODICE ARTICOLO	CODICE INTERNO	GRUPPO DIMENSIONALE	CAPACITÀ Ah	A EN	DIMENSIONI LxPxH (mm)	POLARITÀ	FISSAGGIO ALLA BASE
<b>POWER TECH BATTERY 12V IDROMETRO</b>							
POW4400390	002151	L0	44	390	175X175X190	DX(0/1)	B13
POW5500530	002152	L1	55	530	207X175X190	DX(0/1)	B13
<b>POWER TECH BATTERY 12V</b>							
POW44B0420	002153	L1 B	44	420	207X175X175	DX	B13
POW4400400	002154	L1	44	400	207X175X190	DX	B13
POW60B0600	002155	L2B	60	600	242X175X175	DX	B13
POW6000560	002156	L2	60	560	242X175X190	DX	B13
POW70B0640	002157	L3B	70	640	278X175X175	DX	B13
POW7400640	002158	L3	74	640	278X175X190	DX	B13
POW1000730	001881	L4	100	730	315X175X190	DX	B13
POW85B0780	002159	L4B	85	780	315X175X175	DX	B13
POW9500800	002160	L5	95	800	353X175X190	DX	B13

\*Schemi consultabili a pag. 87

# JAPAN TECH 12V 12V SLI BATTERIES

Batterie concepite per applicazioni specifiche su VEICOLI ASIATICI.

Batteries designed for specific applications on ASIAN VEHICLES.



## BATTERIE 12V VEICOLI ASIATICI 12V JAPAN CAR BATTERY

**ITA** La batteria **JAPAN TECH VIVI Autoparts** è studiata e progettata per soddisfare qualsiasi esigenza; grazie ad elevate prestazioni ed ottimali caratteristiche tecniche e costruttive che permettono di coprire il 95% del parco auto circolante in Europa. La batteria **JAPAN TECH VIVI Autoparts** garantisce massima affidabilità di avviamento grazie ai processi produttivi impiegati e alla qualità dei componenti.

**EN** *The **JAPAN TECH VIVI Autoparts** battery is studied and designed to meet any need; thanks to high performance and excellent technical and construction characteristics that make it possible to cover 95% of the car fleet in circulation in Europe. The **JAPAN TECH VIVI Autoparts** battery guarantees maximum starting reliability thanks to the production processes used and the quality of the components.*

## CARATTERISTICHE FEATURES

**QUALITÀ OE** *OE QUALITY* \_\_\_\_\_

**SENZA MANUTENZIONE** *NO MAINTENANCE* \_\_\_\_\_

**AFFIDABILITÀ DI AVVIAMENTO** \_\_\_\_\_  
*START-UP RELIABILITY*

**SICUREZZA NEL COPERCHIO** *SAFETY IN THE COVER* \_\_\_\_\_  
(SISTEMA FUORIUSCITA DEI GAS AIUTA A PRESERVARE I COMPONENTI  
DEL VANO MOTORE DALLA CORROSIONE  
*GAS RELEASE SYSTEM HELPS TO PRESERVE THE COMPONENTS OF  
THE ENGINE COMPARTMENT FROM CORROSION*)

**PRATICITÀ E FUNZIONALITÀ** \_\_\_\_\_  
*CONVENIENCE AND FUNCTIONALITY*

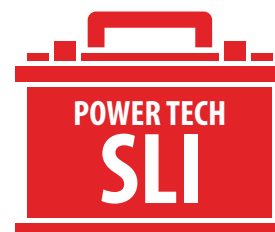

## GAMMA POWER TECH VETTURE ASIATICHE POWER TECH RANGE FOR JAPAN CAR

CODICE ARTICOLO	CODICE INTERNO	GRUPPO DIMENSIONALE	CAPACITA' Ah	A EN	DIMENSIONI LxPxH (mm)	POLARITA'	FISSAGGIO ALLA BASE
<b>POWER TECH BATTERY 12V</b>							
JAP35DP300	002163	JAPAN	35	300	195X127X223	DX piccoli	B00
JAP35SP300	002164	JAPAN	35	300	195X127X224	SX piccoli	B00
JAP35DP130	002165	JAPAN	35	300	195X127X225	DX piccoli PIEDINO	B01
JAP45DP380	002166	JAPAN	45	380	220X135X225	DX piccoli	B00
JAP45SP380	002167	JAPAN	45	380	220X135X225	SX piccoli	B00
JAP45DG380	002168	JAPAN	45	380	236X135X225	DX grandi PIEDINO	B01
JAP45GS380	002169	JAPAN	45	380	236X135X225	SX grandi PIEDINO	B01

\*Schemi consultabili a pag. 87

# TRUCK TECH 12V 12V SLI BATTERIES

Batterie concepite per applicazioni specifiche su VEICOLI TRUCK.

Batteries designed for specific applications on TRUCK VEHICLES.



## BATTERIE 12V TRUCK 12V TRUCK BATTERY

**ITA** La batteria **TRUCK TECH VIVI Autoparts** è studiata e progettata per soddisfare qualsiasi esigenza quando si parla di camion e trattori. Garantisce grandissima affidabilità e ottima resistenza alle vibrazioni grazie all'utilizzo di una resina speciale che contribuisce a rendere le celle ed il monoblocco un unico organismo. Garantisce elevata potenza di avviamento anche in condizioni critiche (basse temperature e carica parziale).

**EN** The **TRUCK TECH VIVI Autoparts** battery is designed and engineered to meet any need when it comes to trucks and tractors. It guarantees great reliability and excellent resistance to vibrations thanks to the use of a special resin that helps to make the cells and the monobloc a single body. It guarantees high starting power even in critical conditions (low temperatures and partial charge).



# CARATTERISTICHE FEATURES

**QUALITÀ OE OE QUALITY** \_\_\_\_\_

**RIDOTTA MANUTENZIONE REDUCED MAINTENANCE** \_\_\_\_\_  
 (NON RICHIEDE RABBOCCHI MA SE NECESSARIO, I TAPPI LO CONSENTONO  
 DOES NOT REQUIRE TOPPING UP BUT IF NECESSARY, THE CAPS ALLOW IT)

**POTENZA DI AVVIAMENTO STARTING POWER** \_\_\_\_\_

**OTTIMA ACCETTAZIONE DI CARICA** \_\_\_\_\_  
 EXCELLENT ACCEPTANCE OF CHARGE

**BUONA DURATA AI CICLI DI CARICA/SCARICA** \_\_\_\_\_  
 GOOD RESISTANCE TO CYCLES  
 OF UPLOAD / DOWNLOAD

**RESISTENZA ALLE VIBRAZIONI** \_\_\_\_\_  
 RESISTANCE TO VIBRATIONS

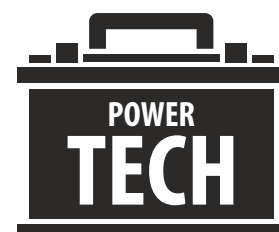

## GAMMA POWER TECH VEICOLI PESANTI POWER TECH RANGE FOR TRUCK

CODICE ARTICOLO	CODICE INTERNO	GRUPPO DIMENSIONALE	CAPACITA' Ah	A EN	DIMENSIONI LxPxH (mm)	POLARITA'	FISSAGGIO ALLA BASE
<b>POWER TECH BATTERY FOR TRUCK</b>							
POW1000720	002161	GR28	100	720	328X175X215	DX(0)	B03
POW1005720	002162	GR28X	100	720	328X175X215	SX(1)	B01
POW1100850	002175	COM100 B01	110	850	349X175X235	DX(0)	B01
POW110D850	002176	COM100	110	850	349X175X235	DX(0)	B00
POW110S850	002177	COM100	110	850	349X175X235	SX(1)	B00
POW120D850	002178	A	120	850	513X189X223	SX(1)	B01 INT
POW120S850	002179	MAC120	120	850	510X175X228	DX(4)	B03
POW1320950	002180	MAT132	132	950	508X175X205	DX(0)	B01
POW16D1050	002182	MAC154	160	1050	510X218X228	DX(4)	B03
POW18S1100	002181	B	180	1100	513X223X223	SX(3)	B00
POW2251150	002183	CX	225	1150	518X273X242	SX(3)	B00

\*Schemi consultabili a pag. 87



# AVVIATORI MANUTENTORI DI BATTERIA INVERTITORI

JUMP STARTER + INTELLIGENT CHARGER  
+ INVERTER

# BATTERY JUMP STARTER

## AVVIATORE TRADIZIONALE A BATTERIA

Avviatore d'emergenza 12V/24V alimentato a batteria. Uno strumento professionale portatile che rappresenta la scelta intramontabile da avere sempre a portata di mano per il recupero di veicoli in panne di ogni cilindrata e tipologia. Alimentato da 2 batterie da 22Ah AGM sigillate al piombo.

Battery powered 12V / 24V emergency jump starter. Portable professional tool that represents the timeless tool to always have at hand for the recovery of broken down vehicles of any engine size and type. Powered by 2 x 22Ah AGM sealed lead acid batteries.

### JS3000A

code: JS3000A051

**CORRENTE DI AVVIO-PICCO/START-PEAK Current:** 3000/1500A

**BATTERIA/BATTERY:** 2x22Ah AGM AL PIOMBO SIGILLATE

2x22 Ah SEALED AGM LEAD ACID BATTERY

**OUTPUT:** 12V 24V jump start



1. ON-OFF 12V o 24V/Power button 12V o 24V
2. Porta di ricarica/Charge port
3. Spia collegamento errato/Bad connection led
4. Pulsante TEST per controllare il livello di carica delle batterie  
TEST button to check the battery charge level
5. Indicatori livello di carica/Charge level indicators
6. Maniglia/Handle
7. Pinze sul retro/Clamps on back

### COME SI UTILIZZA/HOW TO USE



1. Collegare i cavi alla batteria e portare la manopola di accensione in posizione 12V o 24V a seconda del veicolo che si vuole avviare  
Connect cables to the battery and turn the power switch in 12V or 24V position depending on the vehicle you want to start.



2. Accendere il motore  
Start engine



3. Girare l'interruttore in posizione OFF e scollegare i cavi alla batteria  
Turn the power switch in OFF position and disconnect cables to the battery



### CARATTERISTICHE/HIGHLIGHTS



**PROTEZIONE DA RITORNO DI CARICA**  
REVERSE CHARGE PROTECTION



**PROTEZIONE INVERSIONE POLARITA'**  
REVERSE POLARITY PROTECTION



**PROTEZIONE DA CORTO CIRCUITO**  
SHORT-CIRCUIT PROTECTION



**PROTEZIONE DA SOVRATEMPERATURA**  
OVER TEMPERATURE PROTECTION



**PROTEZIONE DA SOVRA CORRENTE**  
OVER CURRENT PROTECTION

### EQUIPAGGIAMENTO/EQUIPMENT



CAVI IN RAME RINFORZATI (35mm<sup>2</sup>)/  
COPPER REINFORCED CABLE



# LITHIUM JUMP STARTER

## AVVIATORE A LITIO

Avviatore d'emergenza professionale 12V/24V, particolarmente consigliato per il recupero di veicoli in panne di ogni cilindrata e tipologia.

Power bank capace di ricaricare dispositivi elettronici dotati di porta USB.

Professional 12V / 24V emergency Jump Starter, particularly recommended for recovery of all types low battery vehicles. Power bank can charging electronic devices with USB port.

### JS2800A

code: JS2800A036

**CORRENTE DI AVVIO-PICCO/START-PEAK Current:** 2800 (12V)

1400A (24V)

**BATTERIA/BATTERY:** 48000mAh (177.5Wh)

**INPUT:** 12V 2A

**OUTPUT:** 5V 2.1A (USB)

12V 8A (accendisigari/cigarette lighter)

12V 24V jump start

**TEMPERATURA/TEMPERATURE:** -10°C to 55°C

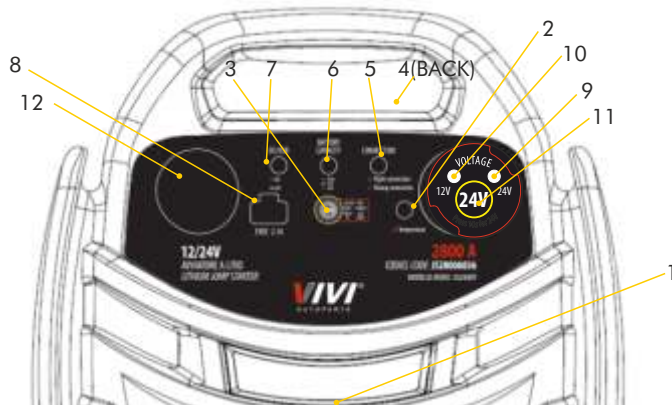

1. Luce LED multifunzionale (5 modalità) / Multifunctional lighting lamp

2. Indicatore di temperatura / Temperature indicator

3. Interruttore multifunzione / Multifunctional switch

4. Porta di ricarica 2.1 (sul retro dell'avviatore) / 2.1 charging interface (on the back)

5. Spia di avvio / Start indicator light

6. Indicatore di carica / Charge indicator

7. Indicatore di funzionamento USB / USB work indicator

8. Porta di uscita USB / USB power output port

9. Indicatore modalità 24V / 24V mode indicator

10. Indicatore modalità 12V / 12V mode indicator

11. Interruttore manuale cambio modalità in 24V / 24V mode manual switch

12. Porta di uscita dell'alimentazione CC dell'accendisigari / DC power output port of cigarette lighter

### COME SI UTILIZZA/HOW TO USE



①



②



③

### CARATTERISTICHE/HIGHLIGHTS



#### REVERSE CHARGE PROTECTION

Protezione dal ritorno di carica.



#### REVERSE CONNECTION PROTECTION

Nessun danno nel caso di connessione inversa.



#### SHORT-CIRCUIT PROTECTION

Protezione dal corto circuito.



#### OVER-CHARGE AND DISCHARGE PROTECTION

Previene il sovraccarico e lo scarico della batteria durante l'avviamento.



#### OVER TEMPERATURE PROTECTION

Si stoppa automaticamente in caso di alte temperature.



#### TIMEOUT PROTECTION

Previene la perdita di carica causata quando l'utente dimentica di spegnere il dispositivo



#### FIREPROOF PROTECTION

Previene le scintille durante il collegamento alla batteria del veicolo e in tutte le altre fasi



# LITHIUM JUMP STARTER

## AVVIATORE A LITIO

Avviatore d'Emergenza 12V per batterie auto capace di avviare veicoli in panne.

Particolarmente consigliato anche come Power bank per chi necessita di ricaricare dispositivi elettronici (tablet, smartphone, macchine fotografiche).

Jump Starter 12V for car batteries to starting low battery vehicles.

Also recommended as a power bank for those who need to recharge electronic devices (tablets, smartphones, cameras).

### JS800A

code: JS800A0026

**CORRENTE DI AVVIO-PICCO/START-PEAK Current:** 800/1600A

**BATTERIA/BATTERY:** 16000mAh (59.2Wh)

**INPUT:** 5V 3A

**OUTPUT:** 5/9/12V

5V/2.1A, DC 12V/10A, 12V jump start

**TEMPERATURA/TEMPERATURE:** -20°C to 60°C



- |                                     |                             |
|-------------------------------------|-----------------------------|
| 1. Accensione/Power button          | 5. USB 5V 2.1A              |
| 2. Schermo led/Led Display          | 6. Luce led/LED flash light |
| 3. Presa di avviamento/Engine start | 7. USB tipo c/Type-c USB    |
| 4. USB 3.0                          | 8. DC output                |

### COME SI UTILIZZA/HOW TO USE

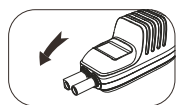

Inserire il cavo di avviamento smart nell'apposito alloggiamento, accendere l'avviatore, attendere che il cavo di avviamento vada in stand-by. Quando è in stand-by e l'avviatore è acceso e lampeggia, è pronto. *Insert smart jump cable in the port, switch on the jump starter power, wait until the clamp cable is in stand-by status. When it is in stand-by status is on and flashing in circle, now the jump starter is ready for jump-starting.*

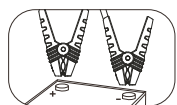

Collegare il cavo con i morsetti alla batteria dell'auto. Il morsetto rosso va al positivo, il morsetto nero va al negativo, prestare particolare attenzione a non invertire la polarità quando si crea il collegamento. *Connect the clamp cable to car battery. Red clamp cable goes to positive, black clamp cable goes to negative, please pay attention to the right polarity terminal and avoid reverse connection.*

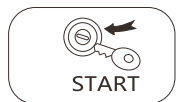

Quando si passa dalla modalità standby all'avviamento, il display LCD sul cavo mostrerà la potenza trasmessa. Il livello di potenza viene misurato ogni 5 secondi; la scarica viene interrotta dopo 20 sec. *When it goes to the jump-starting standby status, the LCD display on clamp cable will show the jump starter voltage. Loading is tested every 5 sec; charging & loading is cut off after 20 sec.*

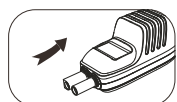

Dopo aver avviato il motore, staccare l'avviatore, quindi scollegare il cavo. *After jump-starting the engine, remove the jump starter first, then disconnect the clamp cable.*

### PROTEZIONI ACCOMPAGNATE DA SEGNALE ACUSTICO/PROTECTIONS WITH BUZZER SIGNAL



**PROTEZIONE DA RITORNO DI CARICA**  
**REVERSE CHARGE PROTECTION**



**PROTEZIONE INVERSIONE POLARITA'**  
**REVERSE POLARITY PROTECTION**



**PROTEZIONE DA CORTO CIRCUITO**  
**SHORT-CIRCUIT PROTECTION**



**PROTEZIONE DA SOVRACCARICO E SCARICA**  
**OVER-CHARGE AND DISCHARGE PROTECTION**



**PROTEZIONE DA SOVRATEMPERATURA**  
**OVER TEMPERATURE PROTECTION**

### EQUIPAGGIAMENTO/EQUIPMENT



CAVO QUICK CHARGE/  
QUICK CHARGE CABLE



CONNETTORE DI AVVIAMENTO/  
JUMP START SOCKET

# LITHIUM JUMP STARTER

## AVVIATORE A LITIO

Avviatore d'Emergenza 12V per batterie auto capace di avviare veicoli in panne.

Particolarmente consigliato anche come Power bank per chi necessita di ricaricare dispositivi elettronici (tablet, smartphone, macchine fotografiche).

Jump Starter 12V for car batteries to starting low battery vehicles.

Also recommended as a power bank for those who need to recharge electronic devices (tablets, smartphones, cameras).

### JS400A

code: JS400A0019

**CORRENTE DI AVVIO-PICCO/START-PEAK Current:** 800/400A

**BATTERIA/BATTERY:** 7200mAh (26.64Wh)

**INPUT:** 5V 3A

**OUTPUT:** 5/9/12V

5V/2.1A, 12V jump start

**TEMPERATURA/TEMPERATURE:** -20°C to 60°C



1. Accensione/Power button
2. Indicatore carica/Energy indicator
3. Presa di avviamento/Engine start
4. USB 5V 2.1A
5. 5V/3A, 9V/2A, 12V 1.5A
6. USB tipo c/Type-c USB
7. ON/OFF

### COME SI UTILIZZA/HOW TO USE

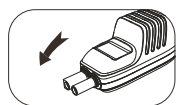

Inserire il cavo di avviamento smart nell'apposito alloggiamento, accendere l'avviatore, attendere che il cavo di avviamento vada in stand-by. Quando è in stand-by e l'avviatore è acceso e lampeggia, è pronto. Insert smart jump cable in the port, switch on the jump starter power, wait until the clamp cable is in stand-by status. When it is in stand-by status is on and flashing in circle, now the jump starter is ready for jump-starting.

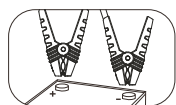

Collegare il cavo con i morsetti alla batteria dell'auto. Il morsetto rosso va al positivo, il morsetto nero va al negativo, prestare particolare attenzione a non invertire la polarità quando si crea il collegamento. Connect the clamp cable to car battery. Red clamp cable goes to positive, black clamp cable goes to negative, please pay attention to the right polarity terminal and avoid reverse connection.

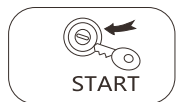

Quando si passa dalla modalità standby all'avviamento, il display LCD sul cavo mostrerà la potenza trasmessa. Il livello di potenza viene misurato ogni 5 secondi; la scarica viene interrotta dopo 20 sec. When it goes to the jump-starting standby status, the LCD display on clamp cable will show the jump starter voltage. Loading is tested every 5 sec; charging & loading is cut off after 20 sec.

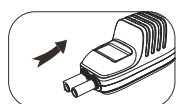

Dopo aver avviato il motore, staccare l'avviatore, quindi scollegare il cavo. After jump-starting the engine, remove the jump starter first, then disconnect the clamp cable.

### PROTEZIONI ACCOMPAGNATE DA SEGNALE ACUSTICO/PROTECTIONS WITH BUZZER SIGNAL



**PROTEZIONE DA RITORNO DI CARICA  
REVERSE CHARGE PROTECTION**



**PROTEZIONE INVERSIONE POLARITA'  
REVERSE POLARITY PROTECTION**



**PROTEZIONE DA CORTO CIRCUITO  
SHORT-CIRCUIT PROTECTION**



**PROTEZIONE DA SOVRACCARICO E SCARICA  
OVER-CHARGE AND DISCHARGE PROTECTION**



**PROTEZIONE DA SOVRATEMPERATURA  
OVER TEMPERATURE PROTECTION**

### EQUIPAGGIAMENTO/EQUIPMENT



CAVO QUICK CHARGE/  
QUICK CHARGE CABLE



CONNETTORE DI AVVIAMENTO/  
JUMP START SOCKET

# INTELLIGENT CHARGER

## MANUTENTORE DI BATTERIA

Manutentore di batteria per auto e mezzi pesanti con funzione di riparazione. Particolarmente indicato per mezzi esposti a lunghi periodi di stop e per la ricarica di batterie al piombo acido. Ha anche funzione di avviamento.

Battery maintainer for cars and heavy vehicles with repair function. Suitable for vehicles exposed to long stop periods and for recharging lead acid batteries. It also has a starter function.

### IC15A

code: IC15ASTART

### BATTERY CHARGER +ENGINE STARTER

**BATTERIE/BATTERY:** START&STOP/PB/CALCIUM/AGM  
GEL BATTERIES (3-300Ah)

**INPUT:** 230V AC

**OUTPUT:** 12/24V DC, 15A, 6 step charging

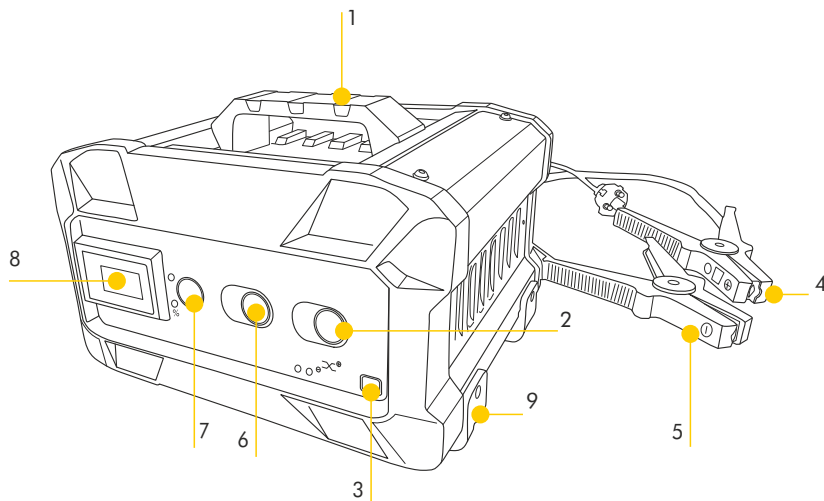

1. MANIGLIA / HANDLE
2. PULSANTE «CURRENT MODE» (caricamento rapido/lento) /  
BUTTON «CURRENT MODE» (fast / slow loading)
3. PULSANTE «ENGINE START» (funzione di avvio del veicolo) /  
BUTTON «ENGINE START» (vehicle starter function)
4. Cavo di ricarica rosso (+) / Red charging cable (+)
5. Cavo di ricarica nero (-) / Black charging cable (-)
6. PULSANTE «BATTERY SELECT» (selezione del tipo di batteria  
12/24V) / BUTTON «BATTERY SELECT» (12 / 24V battery type  
selection)
7. PULSANTE «UNIT» (cambio unità di misura visualizzata sullo  
schermo led) / BUTTON «UNIT» (change of measurement units  
displayed on the led screen)
8. SCHERMO LED / LED SCREEN
9. Piedini di appoggio / Support feet

### MODALITA' DI FUNZIONAMENTO /WORKING MODE



4/15A



4/8A



-20°C+50°C

### CARATTERISTICHE/HIGHLIGHTS



PROTEZIONE DA INVERSIONE DI POLARITA'  
REVERSE POLARITY PROTECTION



PROTEZIONE DA SOVRACCARICO E SCARICO  
OVER-CHARGE AND DISCHARGE PROTECTION

### EQUIPAGGIAMENTO/EQUIPMENT



PINZE  
CLAMPS



SPINA  
PLUG

# INTELLIGENT CHARGER

## MANUTENTORE DI BATTERIA

Manutentore di batteria per auto e moto con funzione di riparazione per desolfatazione. Particolarmente indicato per mezzi esposti a lunghi periodi di stop e per la ricarica di batterie al piombo acido.

Battery maintainer for cars and motorcycles with repair function to desulphation. Suitable for vehicles exposed to long stop periods and for recharging lead acid batteries.

### IC08A

code: **IC08A80088**

**BATTERIE/BATTERY:** WET/AGM/GEL BATTERIES

**INPUT:** 220-240V AC - 0.6A - 50-60Hz

**OUTPUT:** 12V DC - 8A - 9 STEP CHARGING



#### EQUIPAGGIAMENTO/EQUIPMENT

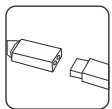

PRESA EASY/  
EASY SOCK



PINZE/  
CLAMPS



ACCENDISIGARI/  
CIGARETTE LIGHTER

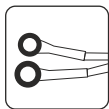

OCCHIELLI/  
EYELETS

#### MODALITA' DI FUNZIONAMENTO/WORKING MODE



14.4V 2A



14.4V 8A



14.7V 8A



REPAIR



DC SUPPLY  
12V 80W

### IC04A

code: **IC04A80049**

**BATTERIE/BATTERY:** WET/AGM/GEL BATTERIES

**INPUT:** 220-240V AC - 0.45A - 50-60Hz

**OUTPUT:** 6/12V DC - 4A - 9 STEP CHARGING



#### MODALITA' DI FUNZIONAMENTO/WORKING MODE



14.4V 1A



14.4V 4A



14.7V 4A



7.5V 4A

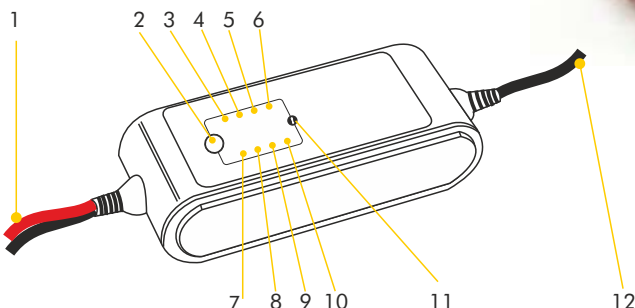

#### EQUIPAGGIAMENTO/EQUIPMENT

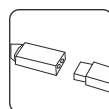

PRESA EASY/  
EASY SOCK



PINZE/  
CLAMPS



ACCENDISIGARI/  
CIGARETTE LIGHTER

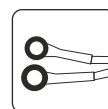

OCCHIELLI/  
EYELETS

- |                         |                              |
|-------------------------|------------------------------|
| 1. Jumper cables        | 7. 14.4V 1A mode             |
| 2. Mode switch          | 8. 14.4V 4A mode             |
| 3. Power lighting       | 9. 14.7V 4A for below 5°C    |
| 4. Battery repairing    | 10. 7.5V 4A for 6V batteries |
| 5. Battery charging     | 11. Fault/Error light        |
| 6. Battery full charged | 12. Power supply cable       |



# INTELLIGENT CHARGER

## MANUTENTORE DI BATTERIA

Manutentore di batteria particolarmente indicato per moto, scooter e mezzi leggeri esposti a lunghi periodi di stop.

Battery maintainer, particularly suitable for motorcycles, scooters and light vehicles exposed to long stop periods.

### IC01A

code: **IC01A00612**

**BATTERIE/BATTERY:** PB/LEAD ACID/AGM/GEL BATTERIES  
(4-60Ah)

**INPUT:** 230V 50Hz

**OUTPUT:** 6/12V DC - 1A - 5 STEP CHARGING

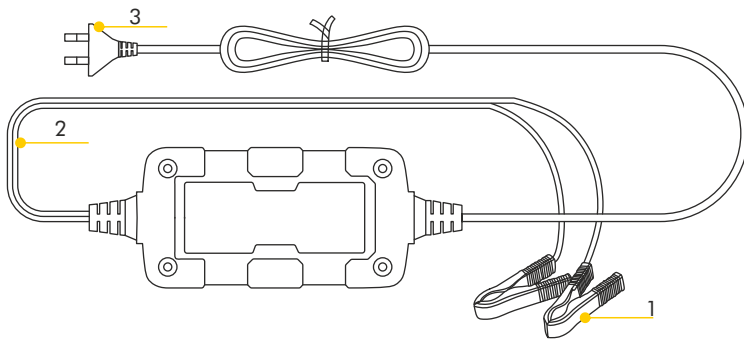

1. Pinze / Clamps
2. Cavo di ricarica / Charge wire
3. Spina / Plug

### MODALITA' DI FUNZIONAMENTO/WORKING MODE



### EQUIPAGGIAMENTO/EQUIPMENT



CONNETTORE  
CONNECTOR



PINZE  
CLAMPS



OCCHIELLI  
EYELETS



SPINA  
PLUG

# INVERTER *INVERTITORI*

## 1000W 12V



Code	CI	Volt	Watt	Pack	EAN
INV1223010	002396	12V-230V	500/1000W	1pc	8051884523965

## 3400W



Code	CI	Volt	Watt	Pack	EAN
INV1223034	002398	12V-230V	1700/3400W	1pc	8051884523989

## 2600W IPS



Code	CI	Volt	Watt	Pack	EAN
INV1223IPS	002399	12V-230V	2600W IPS	1pc	8051884523996

## 1000W 24V



Code	CI	Volt	Watt	Pack	EAN
INV2423010	002397	24V-230V	500/1000W	1pc	8051884523972



# ACCESSORI PER BATTERIA

BATTERY EQUIPMENT

# BOOST CABLE *CAVI DI AVVIAMENTO*

## BC200AIT



Code	CI	Volt	Ampere	Lenght	Section	EAN
BC200A21IT	001556	12/24	200	2,5mt	10mmq	8054317735560

## BC400AIT



Code	CI	Volt	Ampere	Lenght	Section	EAN
BC400A41IT	001557	12/24	400	2,5mt	10mmq	8054317735577

## BC600AIT



Code	CI	Volt	Ampere	Lenght	Section	EAN
BC600A61IT	001558	12/24	600	2,5mt	16mmq	8054317735584

# BATTERY CLAMP *PINZE BATTERIA*

## CLAMP100A



100mm

Code	CI	Volt	Ampere	Type	Pack	EAN
BCLAMP100A	000684	12/24	100	Pos+Neg	2pcs	8053670336841

## CLAMP600A



150mm

Code	CI	Volt	Ampere	Type	Pack	EAN
BCLAMP600A	000683	12/24	600	Pos+Neg	2pcs	8053670336834

## CLAMP1000A



210mm

Code	CI	Volt	Ampere	Type	Pack	EAN
BCLAM1000A	000685	12/24	1000	Pos+Neg	2pcs	8053670336858

# TERMINAL BATTERY

## MORSETTI BATTERIA

### TERMINAL - MORSETTO

PIASTRINA



Code	CI	Volt	Type	Pack	EAN
BTERO1BRP2	001759	12/24	Pos	5pcs	8054317737595
BTERO1BRN2	001760	12/24	Neg	5pcs	8054317737601
BTERO1BR02	000678	12/24	Pos+Neg	2pcs	8053670336780

### TERMINAL - MORSETTO

DADO ALETTA



Code	CI	Volt	Type	Pack	EAN
BTERO2BR02	000679	6/12/24	Pos+Neg	2pcs	8053670336797

### TERMINAL - MORSETTO

DADO ESAGONALE



Code	CI	Volt	Type	Pack	EAN
BTERO3BR02	000680	6/12/24	Pos+Neg	2pcs	8053670336803

### TERMINAL - MORSETTO

GIAPPONESE



Code	CI	Volt	Type	Pack	EAN
BTERO4BR02	001855	12/24	Pos+Neg	2pcs	8054317738554

### TERMINAL - MORSETTO

CAPOCORDA 6+6+6



Code	CI	Volt	Type	Pack	EAN
BTERO5BR02	001877	12/24	Pos+Neg	2pcs	8054317738776

### TERMINAL - MORSETTO

CAPOCORDA 6+8+6



Code	CI	Volt	Type	Pack	EAN
BTERO6BR02	001878	12/24	Pos+Neg	2pcs	8054317738783

### ADAPTERS - ADATTATORI

POLO PICCOLO-POLO GRANDE



Code	CI	Volt	Type	Pack	EAN
ADATPOLIJP	001854	12/24	Small-Big	2pcs	8054317738547

### TERMINAL - MORSETTO

STACCO RAPIDO



Code	CI	Volt	Type	Pack	EAN
BTREM01002	000681	6/12/24	Pos+Neg	2pcs	8053670336810



# BATTERY ACCESSORY

## ACCESSORI BATTERIA

### TERMINAL COVER

COPRI MORSETTI (+ -)



Code	CI	Material	Pack	EAN
CTER01PL02	000682	Plastic	2pcs	8053670336827

### BATTERY TESTER

DENSIMETRO



Code	CI	Material	Pack	EAN
BTEST01001	000686	Plastic	1pc	8053670336865

### BATTERY BRUSH

PULISCI POLI



Code	CI	Material	Pack	EAN
BBRUSH0101	000687	Metal	1pc	8053670336872

# BATTERY SWITCH *STACCABATTERIA*

### 100A



Code	CI	Volt	Ampere	Temperature	EAN
CUTOF0100A	001762	6/12/24	100	-40°+80°	8054317737625

### 1000A



Code	CI	Volt	Ampere	Temperature	EAN
CUTOF1000A	001761	6/12/24	75-1000	-40°+80°	8054317737618

### 2500A



Code	CI	Volt	Ampere	Temperature	EAN
CUTOF2500A	001763	12/24	200-2500	-40°+80°	8054317737632

# BATTERY RELAYS *RELE' BATTERIA*

## 12V RELAY/12V RELE'

20/30A

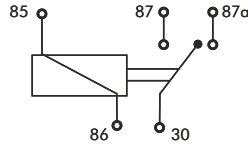
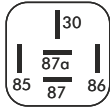

Code	CI	Ampere	Type	EAN
REL12V0561	001765	20/30	Change over opening	8054317737656

30A

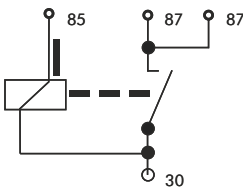
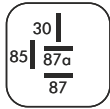

Code	CI	Ampere	Type	EAN
REL12V0541	001764	30	Normal opening	8054317737649

30A



Code	CI	Ampere	Type	EAN
REL12V030A	001856	30	Normal opening	8054317738561

## 24V RELAY/24V RELE'

20A

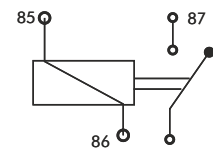
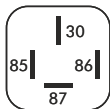

Code	CI	Ampere	Type	EAN
REL12V0551	001766	20	Normal opening	8054317737663

10/20A

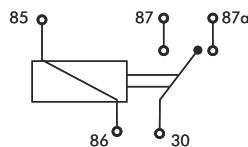
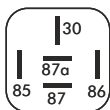

Code	CI	Ampere	Type	EAN
REL12V0571	001767	10/20	Change over opening	8054317737670



# ACCESSORI ELETTRICI

ELECTRIC EQUIPMENT

# SOCKET TRAIL *SPINE CARRELLO*

## 7 SOCKET FEMMINA



Code	CI	Volt	Pin	Material	EAN
METSOC7PIN	001786	12	7	Metal	8054317737861

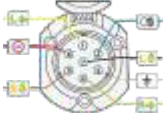

## 7 PLUG MASCHIO



Code	CI	Volt	Pin	Material	EAN
METPLU7PIN	001787	12	7	Metal	8054317737878

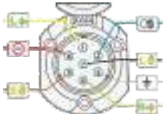

## 13 SOCKET FEMMINA



Code	CI	Volt	Pin	Material	EAN
PLSOC13PIN	001788	12	13	Plastic	8054317737885

## 13 PLUG MASCHIO



Code	CI	Volt	Pin	Material	EAN
PLPLU13PIN	001789	12	13	Plastic	8054317737892

## 13/7 ADAPTER



Code	CI	Volt	Pin	Material	EAN
ADPL137PIN	001790	12	13/7	Plastic	8054317737908

## 7/13 ADAPTER



Code	CI	Volt	Pin	Material	EAN
ADPL713PIN	001791	12	7/13	Plastic	8054317737915

# SOCKET LAMP **CONNETTORI LAMPADE**

H1



Code	CI	ECE	Material	EAN
------	----	-----	----------	-----

H1SOCK0000	000992	H1	Ceramic Body	8053670339927
------------	--------	----	--------------	---------------

H4



Code	CI	ECE	Material	EAN
------	----	-----	----------	-----

H4SOCK0000	000993	H4	Ceramic Body	8053670339934
------------	--------	----	--------------	---------------

H7



Code	CI	ECE	Material	EAN
------	----	-----	----------	-----

H7SOCK0000	000994	H7	Ceramic Body	8053670339941
------------	--------	----	--------------	---------------

H8



Code	CI	ECE	Material	EAN
------	----	-----	----------	-----

H8SOCK0000	000995	H8	Ceramic Body	8053670339958
------------	--------	----	--------------	---------------

H11



Code	CI	ECE	Material	EAN
------	----	-----	----------	-----

H11SOCK000	000996	H11	Ceramic Body	8053670339965
------------	--------	-----	--------------	---------------

HB3-H12



Code	CI	ECE	Material	EAN
------	----	-----	----------	-----

HB3SOCK000	000997	HB3/H12	Ceramic Body	8053670339972
------------	--------	---------	--------------	---------------

HB4



Code	CI	ECE	Material	EAN
------	----	-----	----------	-----

HB4SOCK000	000998	HB4	Ceramic Body	8053670339989
------------	--------	-----	--------------	---------------

# CIGARETTE LIGHTER

## **PRESE ACCENDISIGARI**

2 WAYS

2 VIE



Code	CI	Volt	EAN
------	----	------	-----

CIGLIGHT02	000999	12	8053670339996
------------	--------	----	---------------

3 WAYS

3 VIE



Code	CI	Volt	EAN
------	----	------	-----

CIGLIGHT03	001000	12	8053670330009
------------	--------	----	---------------



# CAR SWITCHES **PULSANTI**

## WATERPROOF SWITCH MICRO/INTERRUPTORE MICRO IMPERMEABILE

Funzione: attivazione a pressione - Dimensioni foro: 28.5x18.5mm - Altezza max: 5mm 3 contatti

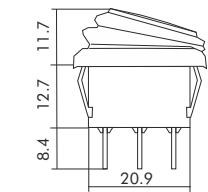

Foro



Code	CI	Volt	Ampere	Colour	EAN
INTMICR10A	001792	12/24	10/5	RED	8054317737922
INTMICG10A	001793	12/24	10/5	GREEN	8054317737939

## STARTER BUTTON SWITCH/INTERRUPTORE DI AVVIO CON PULSANTE

Funzione: attivazione a pressione ON-OFF - Dimensioni foro: Ø22.2 mm - Altezza max: 6mm - 2 contatti

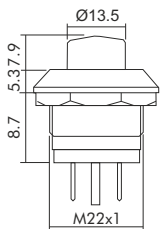

Code	CI	Volt	Ampere	Colour	EAN
INTSTRB20A	001796	12/24	20/10	BLACK	8054317737960
INTSTRR20A	001797	12/24	20/10	RED	8054317737977

## STARTER BUTTON SWITCH METAL/INTERRUPTORE DI AVVIO IN METALLO CON PULSANTE

Funzione: attivazione 2 STEP ON-OFF - Dimensioni foro: Ø16mm - Altezza max: 4mm - 2 contatti

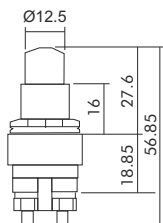

Code	CI	Volt	Ampere	Colour	EAN
INTSTMR60A	001798	12/24	60/30	RED	8054317737984

## STARTER BUTTON SWITCH LED/INTERRUPTORE DI AVVIO CON PULSANTE LED

Funzione: 3 STEP - Dimensioni foro: Ø22mm - Altezza max: 9mm - 2 contatti

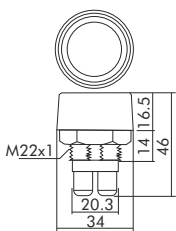

Code	CI	Volt	Ampere	Colour	EAN
INTSTLR50A	001799	12/24	50/25	RED	8054317737991

## PUSH PULL SWITCH /INTERRUPTORE PUSH & PULL

Funzione: attivazione a pressione - Dimensioni foro: Ø8.5 mm - 2 contatti

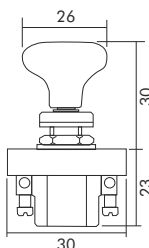

Code	CI	Volt	Ampere	Colour	EAN
INTPPB005A	001800	12	5	BLACK	8054317738004

## TOGGLE LED SWITCH/INTERRUPTORE A LEVETTA CON LED

Funzione: attivazione con leva - Dimensioni foro: Ø12.2 mm - Altezza max: 6mm - 3 contatti

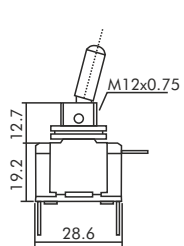

Code	CI	Volt	Ampere	Colour	EAN
INTTGLR20A	001801	12/24	20/10	RED	8054317738011
INTTGLG20A	001802	12/24	20/10	GREEN	8054317738028
INTTGLB20A	001803	12/24	20/10	BLUE	8054317738035

# TERMINALS TERMINALI CAPICORDA

## FEMALE/FEMMINA

2.8



Code	CI	Colour	Material	EAN
CTFEB00028	002401	White	Plastic	8051884524016

2.8



Code	CI	Colour	Material	EAN
TFEB031028	000887	Ø 0.3÷1	Brass	8053670338876

4.8



Code	CI	Colour	Material	EAN
CTFEBP0048	002402	White	Plastic	8051884524023

4.8



Code	CI	Colour	Material	EAN
TFEB052048	000888	Ø 0.5÷2	Brass	8053670338883

6.3



Code	CI	Colour	Material	EAN
CTFEB00063	002403	White	Plastic	8051884524030

6.3



Code	CI	Colour	Material	EAN
TFEB051563	000890	Ø 0.5÷1.5	Brass	8053670338906

6.3



Code	CI	Colour	Material	EAN
TFEB102563	000891	Ø 1÷2.5	Brass	8053670338913

6.3  
NO SLIPPING



Code	CI	Colour	Material	EAN
TFSB102563	000893	Ø 1÷2.5	Brass	8053670338937

HOLDER 4



Code	CI	Colour	Material	EAN
THFEMWT004	000895	White	Polyamide 66 V-2	8053670338951

**MALE/MASCHIO**

4.8



Code	CI	Colour	Material	EAN
TMAB031048	000889	Ø 0.3÷1	Brass	8053670338890

6.3



Code	CI	Colour	Material	EAN
CTMAB00063	002404	White	Plastic	8051884524047

6.3



Code	CI	Colour	Material	EAN
TMAB102563	000892	Ø 1÷2.5	Brass	8053670338920

6.3  
NO SLIPPING



Code	CI	Colour	Material	EAN
TMSB102563	000894	Ø 1÷2.5	Brass	8053670338944

HOLDER 4

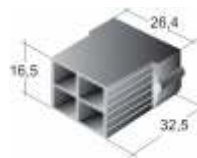

Code	CI	Colour	Material	EAN
THMALWT004	000896	White	Polyamide 66 V-2	8053670338968

**RING/ANELLO**

4.2



Code	CI	Colour	Material	EAN
TRIB102542	000897	Ø 1÷2.5	Brass	8053670338975

5.2



Code	CI	Colour	Material	EAN
TRIB102552	000898	Ø 1÷2.5	Brass	8053670338982

## TERMINALS Range

6.2



Code	CI	Colour	Material	EAN
TRIB102562	000899	Ø 1÷2.5	Brass	8053670338999

8.2



Code	CI	Colour	Material	EAN
TRIB306082	000900	Ø 3÷6	Brass	8053670339002

10.2



Code	CI	Colour	Material	EAN
TRIB306010	000901	Ø 3÷6	Brass	8053670339019

## PIN/PRESA

SOCKET PIN



Code	CI	Colour	Material	EAN
TFPIB00125	000902	Ø 1÷2.5	Brass	8053670339026

PIN



Code	CI	Colour	Material	EAN
TMPIB07520	000903	Ø 0.75÷2	Brass	8053670339033

# BLADE & CILINDER FUSES

## FUSIBILI A LAMA E CILINDRICI

A - SERIES  
BLADE FUSES

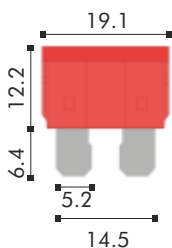
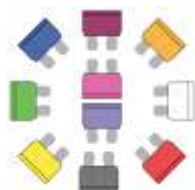

Code	CI	Ampere	Color	Packing	EAN
FUSA3A	000940	3A	PINK	100pcs	8053670339408
FUSA5A	000079	5A	ORANGE	100pcs	8053670330795
FUSA7.5A	000080	7.5A	BROWN	100pcs	8053670330801
FUSA10A	000081	10A	RED	100pcs	8053670330818
FUSA15A	000942	15A	BLUE	100pcs	8053670339422
FUSA20A	000082	20A	YELLOW	100pcs	8053670330825
FUSA25A	000083	25A	WHITE	100pcs	8053670330832
FUSA30A	001403	30A	GREEN	100pcs	8054317734037

B - SERIES  
MINI BLADE FUSES

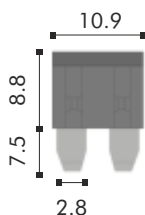

Code	CI	Ampere	Color	Packing	EAN
FUSB3A	000137	3A	PINK	10pcs	8053670331372
FUSB5A	000138	5A	ORANGE	10pcs	8053670331389
FUSB7.5A	000139	7.5A	BROWN	10pcs	8053670331396
FUSB10A	000140	10A	RED	10pcs	8053670331402
FUSB15A	000141	15A	BLUE	10pcs	8053670331419
FUSB20A	000142	20A	YELLOW	10pcs	8053670331426
FUSB25A	000143	25A	WHITE	10pcs	8053670331433
FUSB30A	000144	30A	GREEN	10pcs	8053670331440

**C - SERIES  
MINI BLADE FUSES  
LOW PROFILE**

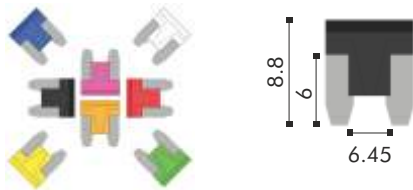

Code	CI	Ampere	Color	Packing	EAN
FUSC3A	000145	3A	PINK	10pcs	8053670331457
FUSC5A	000146	5A	ORANGE	10pcs	8053670331464
FUSC7.5A	000147	7.5A	BROWN	10pcs	8053670331471
FUSC10A	000148	10A	RED	10pcs	8053670331488
FUSC15A	000149	15A	BLUE	10pcs	8053670331495
FUSC20A	000150	20A	YELLOW	10pcs	8053670331501
FUSC25A	000151	25A	WHITE	10pcs	8053670331518
FUSC30A	000192	30A	GREEN	10pcs	8053670331921

**D - SERIES  
MAXI BLADE FUSES**

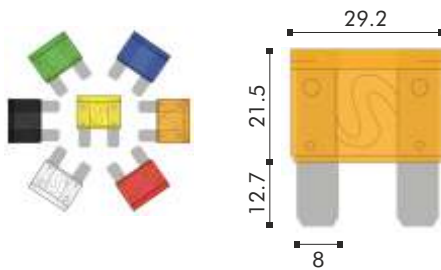

Code	CI	Ampere	Color	Packing	EAN
FUSD20A	000200	20A	YELLOW	10pcs	8053670332003
FUSD30A	000202	30A	GREEN	10pcs	8053670332027
FUSD40A	000204	40A	ORANGE	10pcs	8053670332041
FUSD50A	000211	50A	RED	10pcs	8053670332119
FUSD60A	000213	60A	BLUE	10pcs	8053670332133
FUSD70A	000232	70A	BROWN	10pcs	8053670332324
FUSD80A	000233	80A	WHITE	10pcs	8053670332331

**I - SERIES  
CILINDER FUSES**

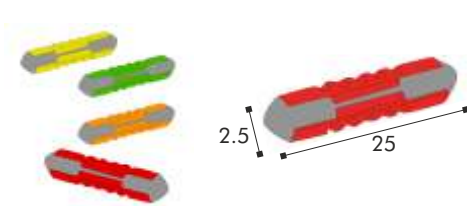

Code	CI	Ampere	Color	Packing	EAN
FUSI5A	000234	5A	YELLOW	50pcs	8053670332348
FUSI8A	000235	8A	WHITE	50pcs	8053670332355
FUSI16A	000236	16A	RED	50pcs	8053670332362
FUSI25A	000941	25A	BLUE	50pcs	8053670339415

# PAL FUSES *FUSIBILI PAL*

**E - SERIES  
PAL FUSES**

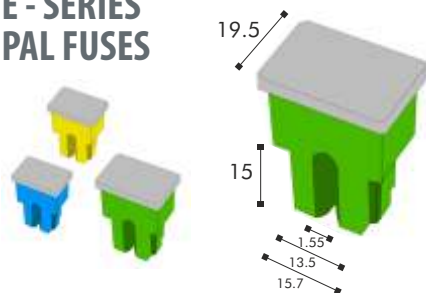

Code	CI	Ampere	Color	Packing	EAN
FUSE20A	000757	20A	BLUE	1pc	8053670337572
FUSE30A	000758	30A	PINK	1pc	8053670337589
FUSE40A	000759	40A	GREEN	1pc	8053670337596
FUSE50A	000760	50A	RED	1pc	8053670337602
FUSE60A	000761	60A	YELLOW	1pc	8053670337619

**F - SERIES  
PAL FUSES**

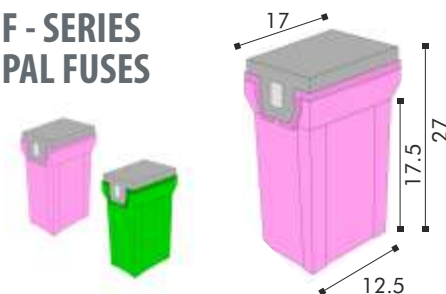

Code	CI	Ampere	Color	Packing	EAN
FUSF30A	000750	30A	PINK	1pc	8053670337503
FUSF40A	000751	40A	GREEN	1pc	8053670337510



## PAL FUSES Range

### M - SERIES PAL FUSES

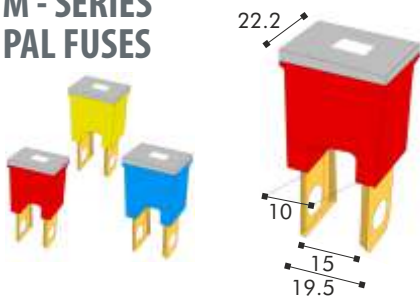

Code	CI	Ampere	Color	Packing	EAN
FUSM20A	000768	20A	■ BLUE	1pc	8053670337688
FUSM30A	000769	30A	■ PINK	1pc	8053670337695
FUSM40A	000770	40A	■ GREEN	1pc	8053670337701
FUSM50A	000771	50A	■ RED	1pc	8053670337718
FUSM60A	000772	60A	■ YELLOW	1pc	8053670337725
FUSM70A	000773	70A	■ GREY	1pc	8053670337732
FUSM80A	000774	80A	■ BLACK	1pc	8053670337749
FUSM100A	000775	100A	■ BLUE	1pc	8053670337756
FUSM120A	000776	120A	□ WHITE	1pc	8053670337763

### N - SERIES PAL FUSES

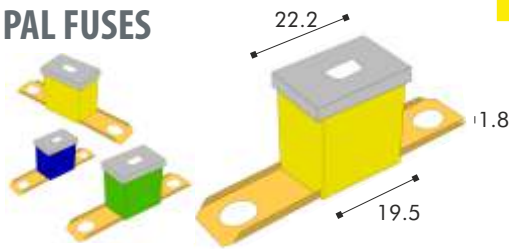

Code	CI	Ampere	Color	Packing	EAN
FUSN30A	000777	30A	■ PINK	1pc	8053670337770
FUSN40A	000778	40A	■ GREEN	1pc	8053670337787
FUSN50A	000779	50A	■ RED	1pc	8053670337794
FUSN60A	000780	60A	■ YELLOW	1pc	8053670337800
FUSN70A	000781	70A	■ GREY	1pc	8053670337817
FUSN80A	000782	80A	■ BLACK	1pc	8053670337824
FUSN100A	000783	100A	■ BLUE	1pc	8053670337831
FUSN120A	000784	120A	□ WHITE	1pc	8053670337848

### O - SERIES PAL FUSES

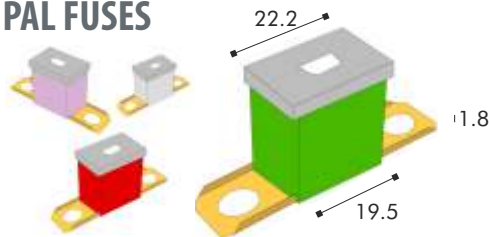

Code	CI	Ampere	Color	Packing	EAN
FUSO30A	000785	30A	■ PINK	1pc	8053670337855
FUSO40A	000786	40A	■ GREEN	1pc	8053670337862
FUSO50A	000787	50A	■ RED	1pc	8053670337879
FUSO60A	000788	60A	■ YELLOW	1pc	8053670337886
FUSO70A	000789	70A	■ GREY	1pc	8053670337893
FUSO80A	000790	80A	■ BLACK	1pc	8053670337909
FUSO100A	000791	100A	■ BLUE	1pc	8053670337916
FUSO120A	000792	120A	□ WHITE	1pc	8053670337923

# PAL-JCASE FUSES *FUSIBILI PAL-JCASE*

### O - SERIES PAL FUSES

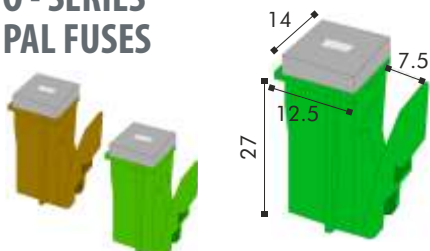

Code	CI	Ampere	Color	Packing	EAN
FUSP25A	000793	25A	■ BROWN	1pc	8053670337930
FUSP30A	000794	30A	■ GREEN	1pc	8053670337947

### Q - SERIES PAL FUSES

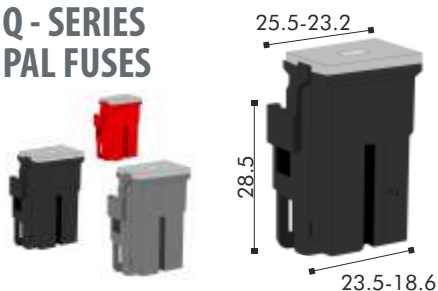

Code	CI	Ampere	Color	Packing	EAN
FUSQ45A	000795	45A	■ VIOLET	1pc	8053670337954
FUSQ65A	000796	65A	■ BLACK	1pc	8053670337961
FUSQ75A	000797	75A	■ GREY	1pc	8053670337978

**L - SERIES  
PAL FUSES**

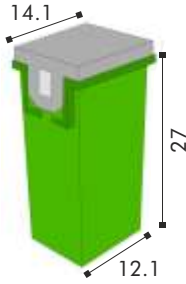

Code	CI	Ampere	Color	Packing	EAN
FUSL20A	000752	20A	■ BLUE	1pc	8053670337527
FUSL30A	000753	30A	■ PINK	1pc	8053670337534
FUSL40A	000754	40A	■ GREEN	1pc	8053670337541
FUSL50A	000755	50A	■ RED	1pc	8053670337558
FUSL60A	000756	60A	■ YELLOW	1pc	8053670337565

**H - SERIES  
PAL FUSES**

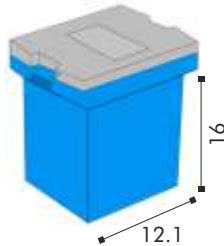

Code	CI	Ampere	Color	Packing	EAN
FUSH20A	000762	20A	■ BLUE	1pc	8053670337626
FUSH25A	000763	25A	□ WHITE	1pc	8053670337633
FUSH30A	000764	30A	■ PINK	1pc	8053670337640
FUSH40A	000765	40A	■ GREEN	1pc	8053670337657
FUSH50A	000766	50A	■ RED	1pc	8053670337664
FUSH60A	000767	60A	■ YELLOW	1pc	8053670337671

# MIDI-MEGA FUSES

## FUSIBILI MIDI-MEGA

**R - SERIES  
MIDI FUSES**

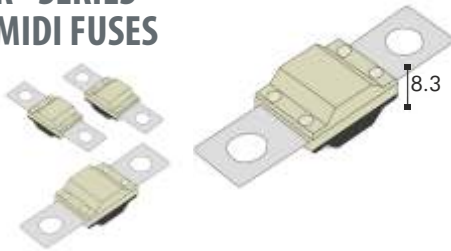

Code	CI	Ampere	Color	Packing	EAN
FUSR30A	000798	30A	□ NEUTRAL	1pc	8053670337985
FUSR40A	000799	40A	□ NEUTRAL	1pc	8053670337992
FUSR50A	000800	50A	□ NEUTRAL	1pc	8053670338005
FUSR60A	000801	60A	□ NEUTRAL	1pc	8053670338012
FUSR70A	000802	70A	□ NEUTRAL	1pc	8053670338029
FUSR80A	000803	80A	□ NEUTRAL	1pc	8053670338036
FUSR100A	000804	100A	□ NEUTRAL	1pc	8053670338043
FUSR125A	000805	125A	□ NEUTRAL	1pc	8053670338050
FUSR150A	000806	150A	□ NEUTRAL	1pc	8053670338067
FUSR175A	000807	175A	□ NEUTRAL	1pc	8053670338074

**S - SERIES  
MEGA FUSES**

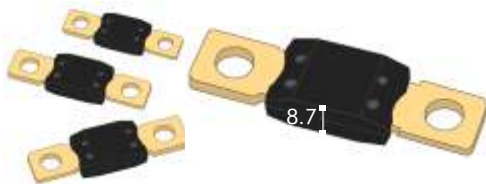

Code	CI	Ampere	Color	Packing	EAN
FUSS100A	000808	100A	■ BLACK	1pc	8053670338081
FUSS125A	000809	125A	■ BLACK	1pc	8053670338098
FUSS150A	000810	150A	■ BLACK	1pc	8053670338104
FUSS175A	000811	175A	■ BLACK	1pc	8053670338111
FUSS200A	000812	200A	■ BLACK	1pc	8053670338128
FUSS225A	000813	225A	■ BLACK	1pc	8053670338135
FUSS250A	000814	250A	■ BLACK	1pc	8053670338142
FUSS300A	000815	300A	■ BLACK	1pc	8053670338159

**FUSE BOX  
FOR BLADE FUSES**



Code	CI	Color	Packing	EAN
FUSEBOX9P*	002188	□ TRASPARENT	1pc	8051884521886

\*la scatola si intende vuota/the box is considered empty

# FUSE HOLDER *PORTAFUSIBILI*

## EXTRACTOR/ESTRATTORE

### EXTRACTOR FUSE BLADE-GLASS A/T SERIES



Code	CI	EAN
EXFUSA000A	000860	8053670338609

### EXTRACTOR FUSE MINI BLADE B-SERIES



Code	CI	EAN
EXFUSB000A	000861	8053670338616

## HOLDER/PORTA FUSIBILI

### HOLDER FUSE BLADE A-SERIES max30A-BAKELITE



Code	CI	EAN
HB1FUSA30A	000859	8053670338593

### HOLDER FUSE BLADE A-SERIES max30A



Code	CI	EAN
HW1FUSA30A	000857	8053670338579

### HOLDER FUSE MAXI BLADE D-SERIES max80A



Code	CI	EAN
HW1FUSD80A	000858	8053670338586

### HOLDER FUSE FLAT-MIDI R-SERIES max100A



Code	CI	EAN
H1FUSR100A	000853	8053670338531

### HOLDER FUSE FLAT-MIDI 2 R-SERIES max150A



Code	CI	EAN
H2FUSR150A	000854	8053670338548

### HOLDER FUSE MEGA S-SERIES max250A-ASIMMETRICO



Code	CI	EAN
HAFUSS250A	000855	8053670338555

### HOLDER FUSE MEGA S-SERIES max250A-SIMMETRICO



Code	CI	EAN
HSFUSS250A	000856	8053670338562

### HOLDER FUSE GLASS T-SERIES max30A



Code	CI	EAN
HW1FUST30A	000852	8053670338524

# DISC HORN **CLACSON**

## CLACSON



Code	CI	Volt	Dimension	EAN
DHORN0012V	001768	12	109x88x50	8054317737687
DHORN0024V	001769	24	109x88x50	8054317737694

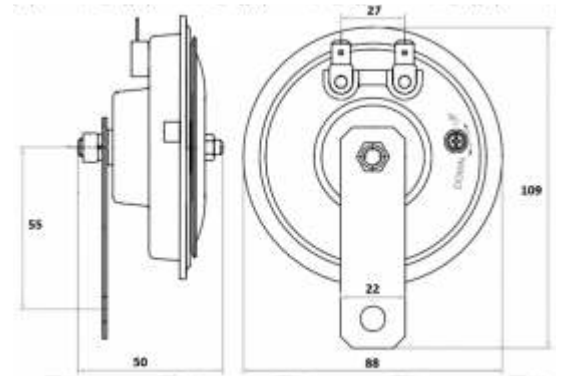

## CLACSON ELETTRICO



Code	CI	Volt	Dimension	EAN
EHORN2012V	002185	12	113x90x85	8051884521855
EHORN2024V	002184	24	113x90x85	8051884521848

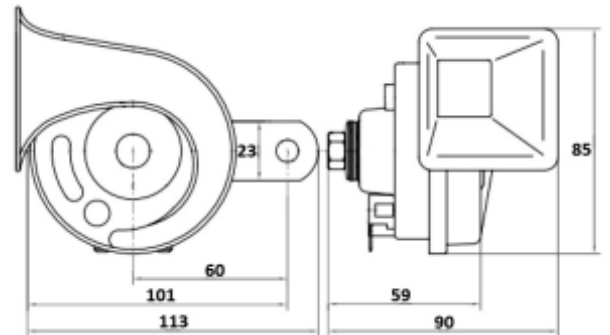

## AVVISATORE ACUSTICO RETROMARCIA



Code	CI	Volt	Dimension	EAN
RHORN01224	002174	12/24V	---	8051884521749





# ILLUMINAZIONE DA LAVORO



WORKING LIGHT



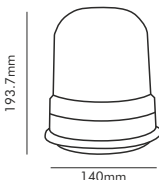

# ROTANTING BEACON

## ROTANTI LED ALOGENO

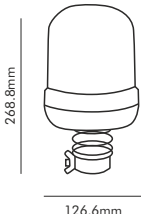

### WRH01

IMG	Code	CI	Volt	Type	Base	Joint	Color	EAN
	WRH01MGPLA	001407	12/24	Halogen Alogeno (H1)	Magnetic Magnetica	Lighter Accendisigari	Orange Arancio	8054317734075
								 

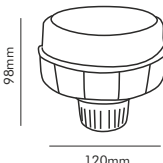

### WRH02

IMG	Code	CI	Volt	Type	Base	Joint	Color	EAN
	WRH02FLATA	001408	12/24	Halogen Alogeno (H1)	Bar flex Asta Flex	Bar Asta	Orange Arancio	8054317734082
								 

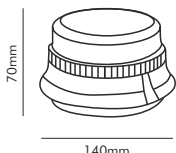

### WRL08

IMG	Code	CI	Volt	Type	Base	Joint	Color	EAN
	WRL08FLATA	001412	12/24	LED	Pin Perno	Pin Perno	Orange Arancio	8054317734129
								 

### WRL12F

IMG	Code	CI	Volt	Type	Base	Joint	Color	EAN
	WRL12FIWRA	001413	12/24	LED	Fixed Fissa	Cable Filo	Orange Arancio	8054317734136
								 

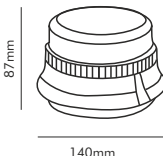
### WRL12M

IMG	Code	CI	Volt	Type	Base	Joint	Color	EAN
	WRL12MGPLA	001414	12/24	LED	Magnetic Magnetica	Lighter Accendisigari	Orange Arancio	8054317734143
								 

**WRL18M**

IMG	Code	CI	Volt	Type	Base	Joint	Color	EAN
-----	------	----	------	------	------	-------	-------	-----



WRL18MGPLA	001543	12/24	LED	Magnetic Magnetica	Lighter Accendisigari	Orange Arancio	8054317735430
------------	--------	-------	-----	--------------------	-----------------------	----------------	---------------



WLR18MGBLU	001876	12/24	LED	Magnetic Magnetica	Lighter Accendisigari	Blue Blu	8054317738769
------------	--------	-------	-----	--------------------	-----------------------	----------	---------------

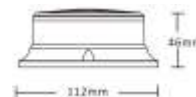

**LAMP HOLDER/PORTALAMPADE**

**T-TYPE**

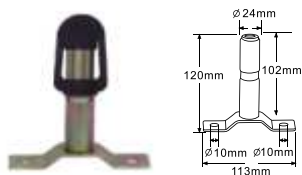

code: LMHOLD120T  
CI001754  
EAN: 8054317737540

**U-TYPE**



code: LMHOLD121U  
CI001755  
EAN: 8054317737557

**I-TYPE**

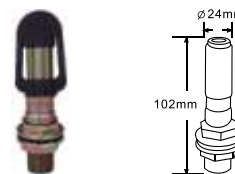

code: LMHOLD102I  
CI001756  
EAN: 8054317737564

**L-TYPE**

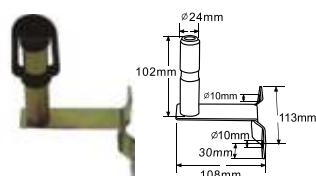

code: LMHOLD102L  
CI001757  
EAN: 8054317737571

**O-TYPE**



code: LMHOLD102O  
CI001758  
EAN: 8054317737588

**VISIBILITY LIGHT VISIBILITA'**

**TRAFFIC GUIDE LIGHT**

- 5 PCS
- WATERPROOF
- RECHARGEABLE (inside the case)
- SAFETY LIGHTS
- CRUSH PROOF



Code	CI	Led	EAN
------	----	-----	-----

TORSAFEL5	001652	6	8054317736529
-----------	--------	---	---------------

**EMERGENCY TRIANGLE**



Code	CI	Colour	EAN
------	----	--------	-----

TRISAFE012	001745	RED	8054317737458
------------	--------	-----	---------------

## REFLECTIVE VEST

OMOLOGAZIONE EN 20471/2013



Code	CI	Led	EAN
REFLVEST01	001746	---	8054317737465

# LED WARNING LIGHT

## LUCI EMERGENZA

### WL401 REVERSE GEAR LIGHT

IMG	Code	CI	Volt	Watt	Led	Lumen	Color	EAN
-----	------	----	------	------	-----	-------	-------	-----



WL4010206W 000879 9-80 6 2 --- BLUE 8053670338791

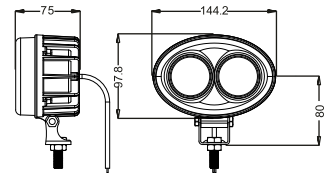

### WL401 BLUE

IMG	Code	CI	Volt	Watt	Led	Lumen	Color	EAN
-----	------	----	------	------	-----	-------	-------	-----



WL4010303B 001415 12/24 --- 3 --- BLUE 8054317734150

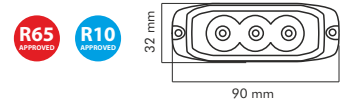

### WL403

IMG	Code	CI	Volt	Watt	Led	Lumen	Color	EAN
-----	------	----	------	------	-----	-------	-------	-----



WL4030618W 000272 12/24 18 6 --- AMBER 8053670332720

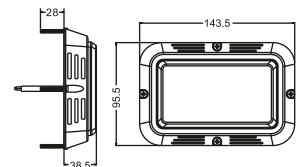

### WL412 LUCE MODULABILE

IMG	Code	CI	Volt	Watt	Led	Lumen	Color	EAN
-----	------	----	------	------	-----	-------	-------	-----



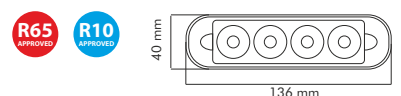

WL4120403A 001409 12/24 --- 4 --- AMBER 8054317734099



## LED WARNING LIGHT Range

### WL413 LUCE MODULABILE

IMG	Code	CI	Volt	Watt	Led	Lumen	Color	EAN
	WL4130603A	001410	12/24	---	6	---	AMBER	8054317734105

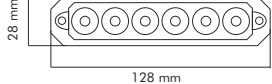
### WL414 LUCE MODULABILE

IMG	Code	CI	Volt	Watt	Led	Lumen	Color	EAN
	WL4140703A	001952	12/24	7	6	---	AMBER	8054317739520

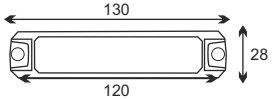

# LED WARNING BAR

## BARRE LED EMERGENZA

### MINI WARNING LED BAR 42W

IMG	Code	CI	Volt	Watt	Led	Lumen	Color	EAN
	LWB1224042	002437	12/24	42	72	---	AMBER	8051884524375

Montaggio Mounting: Base magnetica Magnetic base  
 Funzioni Functions: 1 modalità flash 1 warning flash  
 Cavo spiralato da 3 metri con spina accendisigari 3mt spiral cable with plug for lighter socket

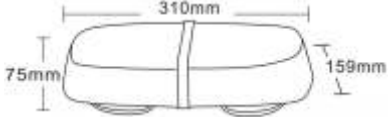
### WARNING LED BAR 82W - 98W - 106W

Code	CI	Volt	Watt	Led	Dimension	Color	EAN
LWB1224082	002438	12/24	82	132	766x218x80.7	AMBER	8051884524382
LWB1224098	002439	12/24	98	180	1070x218x80.7	AMBER	8051884524399
LWB1224106	002440	12/24	106	204	1223x218x80.7	AMBER	8051884524405

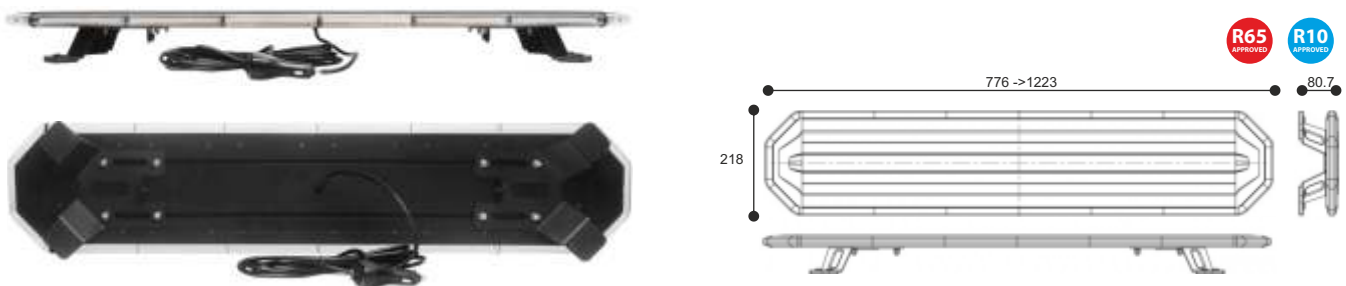

Montaggio Mounting: Viti Screws  
 Funzioni Functions: 4 modalità flash giorno/notte con controller  
 4 warning flashes, intensity day and night, control box  
 Cavo spiralato da 5 metri 5mt cable

# CLUTTERED LIGHTS

## LUCI INGOMBRO

### LDL02 LUCE INGOMBRO CON STAFFA

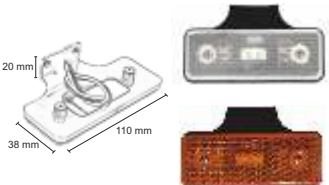
IMG	Code	CI	Volt	Watt	Led	Lumen	Color	EAN
	LDL02WHITE	001544	12/24	---	2	---	WHITE	8054317735447
	LDL02ORANG	001545	12/24	---	2	---	ORANGE	8054317735454

### LDL10 LUCE INGOMBRO

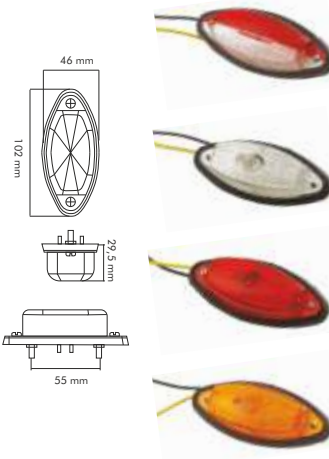
IMG	Code	CI	Volt	Watt	Led	Lumen	Color	EAN
	LDL10WHRED	001730	12/24	---	2	---	WHITE RED	8054317737304
	LDL10WHITE	001731	12/24	---	2	---	WHITE	8054317737311
	LDL100RED	001732	12/24	---	2	---	RED	8054317737328
	LDL10ORANG	001733	12/24	---	2	---	ORANGE	8054317737335

# REFLECTOR LIGHT

## CATARINFRANGENTI

### REFL63

Code	CI	Dimension	Fix	Color	EAN
REFL63WHIT	001739	63mm	1 SCREW	WHITE	8054317737397
REFL63RED	001740	63mm	1 SCREW	RED	8054317737403

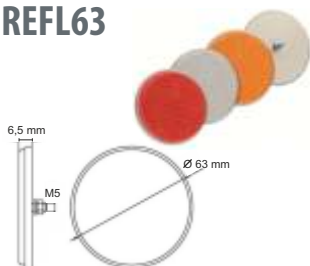



## REFLECTOR LIGHT Range

### REFL81

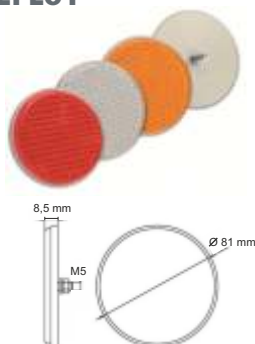

Code	CI	Dimension	Fix	Color	EAN
REFL81WHIT	001741	81mm	1 SCREW	WHITE	8054317737410
REFL81ORAN	001742	81mm	1 SCREW	ORANGE	8054317737427
REFL81RED	001743	81mm	1 SCREW	RED	8054317737434

### REFLW TRIANGOLO



Code	CI	Dimension	Fix	Color	EAN
REFLWRTRIAN	001744	140x160mm	2 SCREWS	WHITE & RED	8054317737441

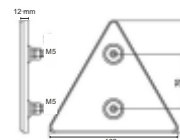

### IVECO LENS LENTI IVECO



Code	CI	Dimension	Fix	Type	EAN
LNPDXIVECO	001752	305x130x83mm	4 SCREW	RETROMARCIA	8054317737526
LNPSXIVECO	001753	305x130x83mm	4 SCREW	RETRONEBBIA	8054317737533

### RIBBON NASTRO



Code	CI	Heigh	Lenght	EAN
NASORAN50M	002330	55mm	50m	8051884523309
NASWHI50M	002331	55mm	50m	8051884523316
NASTRED50M	002332	55mm	50m	8051884523323

# PLATE LIGHTS *LUCI TARGA*

## PLIG5W

IMG	Code	CI	Volt	Watt	Led	Fix	Pack	EAN
-----	------	----	------	------	-----	-----	------	-----



1224PLIG5W	001747	12/24	5	---	2 SCREW	2pcs	8054317737472
------------	--------	-------	---	-----	---------	------	---------------

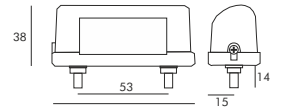

## PLIG3L

IMG	Code	CI	Volt	Watt	Led	Fix	Pack	EAN
-----	------	----	------	------	-----	-----	------	-----



1224PLIG3L	001748	12/24	0.3/0.6	3	2 SCREW	1pc	8054317737489
------------	--------	-------	---------	---	---------	-----	---------------

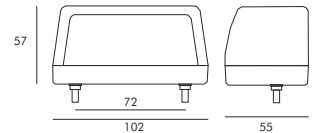

# TRAIL LIGHTS *LUCI CARRELLO*

## TLIG 20

IMG	Code	CI	Dimension	Led	Volts	EAN
-----	------	----	-----------	-----	-------	-----



1224TLIG20	001749	105x95x28.5mm	20	12/24V	8054317737496
------------	--------	---------------	----	--------	---------------

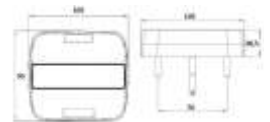

## TL25DX

IMG	Code	CI	Dimension	Led	Volts	EAN
-----	------	----	-----------	-----	-------	-----



1224TL25DX	001750	106x99x35mm	25 led Destro	12/24V	8054317737502
------------	--------	-------------	---------------	--------	---------------

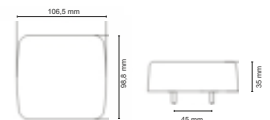

## TLM25

IMG	Code	CI	Dimension	Led	Volts	EAN
-----	------	----	-----------	-----	-------	-----



1224TLM25	001751	(130+99)x106mm Cavo da 7,5 mt 7PIN PLUG	25 led Magnetico	12/24	8054317737519
-----------	--------	---	------------------	-------	---------------

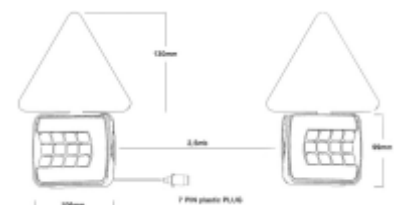

# LED TORCHES TORCE LED

## EASY TORCH Range

ECONOMICHE - COMPATTE - LEGGERE - FLESSIBILI

### TORCH D5



Code	CI	Battery	Led	Lumen	Working Time	Charging Time	EAN
------	----	---------	-----	-------	--------------	---------------	-----

TOR4024D5L 000229 3 pcs AAA 6 200/100 --- --- 8053670332294

Torcia a pile per ispezione dal formato compatto. Doppia illuminazione LED con base snodabile. Dotata di gancio e calamita.  
Compact size battery-powered inspection torch. Double LED lighting with articulated base. Equipped with hook and magnet.

### EASYFLEX SMALL

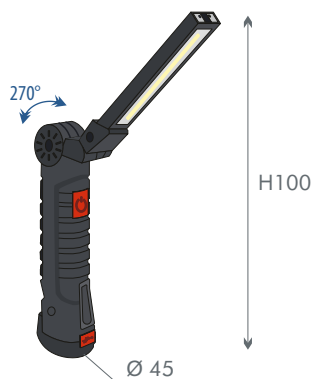

Code	CI	Battery	Led	Lumen	Working Time	Charging Time	EAN
------	----	---------	-----	-------	--------------	---------------	-----

TOREASY01S 001649 Li 3.7V 600mAh 3W COB 50/200 2-8h 3/4h 8054317736499

Torcia piccola da ispezione ricaricabile di elevata qualità, perfetta per uso professionale e privato. Intensità di illuminazione regolabile giusta per qualsiasi compito da svolgere. Offre una luminosità massima di 200lumen e una minima di 50lumen. 3 tipi di illuminazione LED. Torcia orientabile con snodo fino a 270°, base calamitata.

Small rechargeable inspection torch, perfect for professional and private use. Adjustable light intensity right for any task at hand. Brightness from 200lumen to 50lumen. 3 types of LED lighting. Adjustable torch with joint up to 270°, magnetic base.

### EASYFLEX PLUS



Code	CI	Battery	Led	Lumen	Working Time	Charging Time	EAN
------	----	---------	-----	-------	--------------	---------------	-----

TOREASY02B 001867 Li 3.7V 2000mAh 3W+ 5W COB 150/360 3-4.5h 4h 8054317738677

Torcia da ispezione ricaricabile di elevata qualità, perfetta per uso professionale e privato. Intensità di illuminazione regolabile giusta per qualsiasi compito da svolgere. Offre una luminosità massima di 360 lumen e una minima di 150 lumen. 3 tipi di illuminazione LED. Torcia orientabile con snodo fino a 270°, base calamitata e gancio snodabile.

Rechargeable inspection torch, perfect for professional and private use. Adjustable light intensity right for any task at hand. Brightness from 360 lumens to 150 lumens. 3 types of LED lighting. Adjustable torch with joint up to 270°, magnetic base and articulated hook.

### EASYROLL 2.0



Code	CI	Battery	Led	Lumen	Working Time	Charging Time	EAN
------	----	---------	-----	-------	--------------	---------------	-----

TOREASY06A 001866 Li 3.7V 2200mAh 5W COB 70/450 3-6h 3-4h 8054317738660

Torcia da ispezione ricaricabile di elevata qualità, perfetta per uso professionale e privato. Intensità di illuminazione regolabile giusta per qualsiasi compito da svolgere. Offre una luminosità massima di 700 lumen e una minima di 70 lumen. Torcia pieghevole con base girevole magnetica, con gancio.

Rechargeable inspection torch, perfect for professional and private use. Adjustable light intensity right for any task at hand. Brightness from 700 lumens to 70 lumens. Foldable flashlight with magnetic swivel base, with hook.

## INSPECTION TORCH



Code	CI	Battery	Led	Lumen	Working Time	Charging Time	EAN
TORISP1LED	000231	3 pcs AAA	1	100	---	---	8053670332317

Torcia a pile molto utile per illuminare zone nascoste. Dotata di una punta magnetica per il recupero di oggetti metallici. Lunghezza cavo di 500mm.  
*Very useful battery torch for illuminating hidden areas. Equipped with a magnetic tip for the recovery of metal objects. Cable length of 500mm.*

## XLIFE TORCH Range

RESISTENTI A CADUTA DA 2 METRI - PROFESSIONALI - LA NUOVA FRONTIERA DELLA LUCE

## EXTRA FOLD 700



Code	CI	Battery	Led	Lumen	Working Time	Charging Time	EAN
TORXL00700	001868	Li 3.7V 2600mAh	COB+ SMD LED	120/700	16-2h	4h	8054317738684

Torcia da ispezione ricaricabile di elevata qualità, perfetta per uso professionale e privato. Diverse modalità di regolazione, con una tripla rotazione fino a 180°. Offre una luminosità massima di 700 lumen e una funzione torcia di 70 lumen. Dotata di dimmerizzatore, magnete e gancio.  
 Resistente a caduta di 2 M.

*HQ rechargeable inspection torch, perfect for professional and private use. Different adjustment modes, with a triple rotation up to 180°. Brightness at 700 lumens and a flashlight function of 70 lumens. Equipped with dimmer, magnet and hook. 2M drop resistant.*

## ULTRA SLIM



Code	CI	Battery	Led	Lumen	Working Time	Charging Time	EAN
TORXL00200	001869	Li 3.7V 700mAh	COB+ SMD LED	80/200	4-2h	2.5h	8054317738691

Torcia snodabile ricaricabile di elevata qualità, perfetta per uso professionale e privato. Diverse modalità di regolazione. Offre una luminosità massima di 700 lumen. 4 tipi di illuminazione LED.  
 Dotata di base calamitata con gancio snodabile. Resistente a caduta di 2 M.

*HQ rechargeable articulated flashlight, perfect for professional and private use. Different adjustment modes. Brightness of 700 lumens. 4 types of LED lighting. Equipped with magnetic base with articulated hook. 2M drop resistant.*

## HAND POCKET LIGHT



Code	CI	Battery	Led	Lumen	Working Time	Charging Time	EAN
TORXL20120	001870	Li 3.7V 2600mAh	7WCOB+ 3WSMD LED	100/700	2-10h	4h	8054317738707

Torcia da ispezione ricaricabile di elevata qualità, perfetta ad uso professionale e privato. 4 step di illuminazione LED, massima illuminazione di 700 lumen e massima di 100 lumen. Base calamitata e snodabile fino a 180°.

*HQ rechargeable inspection torch, perfect for professional and private use. 4 steps of LED lighting, maximum illumination of 700 lumens and maximum of 100 lumens. Magnetic base and articulated up to 180°.*

### TORCH D9



Code	CI	Battery	Led	Lumen	Working Time	Charging Time	EAN
TOR4024D9L	001053	Li 3.7V	2W COB	300	4h	3h	8054317730534

Torcia LED per ispezione al litio ricaricabile. Doppia illuminazione di 300 lumen. Dotata di calamita e aggancio con moschettone.

Rechargeable lithium LED inspection torch. Double illumination of 300 lumens. Equipped with magnet and metal hook.

### SENSOR HEADLAMP



Code	CI	Battery	Led	Lumen	Working Time	Charging Time	EAN
TORHD150LM	001717	Li 3.7V 2200mAh	3W COB	150	4-16h	4h	8054317737175

Potente torcia per la fronte, illuminazione LED con sensore di movimento. Utilizzabile per ispezione e manutenzione dei veicoli e a casa, utile per avere mani libere. Offre una luminosità massima di 150 lumen. Batteria al litio ricaricabile.

Powerful flashlight for the forehead, LED lighting with motion sensor. Can be used for inspection and maintenance of vehicles and at home, useful for having hands free. It offers a maximum brightness of 150 lumens. Rechargeable lithium battery.



## PROFESSIONAL ALUMINIUM TORCH Range

CORPO IN ALLUMINIO - PROFESSIONALI - POTENTI - PRECISIONE ASSOLUTA

### SUPER PEN



Code	CI	Battery	Led	Lumen	Working Time	Charging Time	EAN
TORAL1PEN	001643	Li 3.7V 750mAh	1W COB	80	4-1h	1h	8054317736437

Torcia in alluminio ricaricabile a LED ad alte prestazioni. Garantisce un'illuminazione professionale modulabile. Massima illuminazione di 80 lumen.

High performance rechargeable aluminum LED flashlight. It guarantees modular professional lighting. Maximum illumination of 80 lumens.

### SUPER 500



Code	CI	Battery	Led	Lumen	Working Time	Charging Time	EAN
TORAL500LM	001644	Li 3.7V 1500mAh	1W+ 5W COB	500	3-7h	3h	8054317736444

Torcia in alluminio ricaricabile potente, perfetta per uso professionale e privato. Offre 3 tipi diversi tipi di illuminazione. Illumina fino a 40M con una luminosità massima di 500 lumen.

Powerful rechargeable aluminum flashlight, perfect for professional and private use. It offers 3 different types of lighting. Illuminates up to 40M with a maximum brightness of 500 lumens.



## SPECIAL TORCH Range

FARETTI - PROFESSIONALI - PER UTILIZZI SPECIALI

## SPOTLIGHT 10W

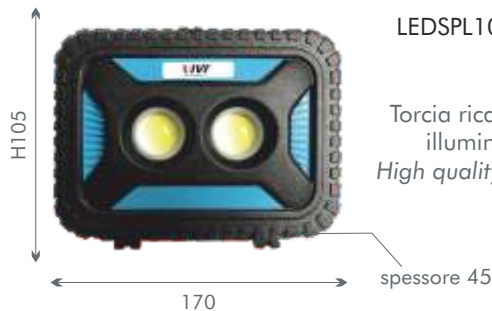

Code	CI	Battery	Led	Lumen	Working Time	Charging Time	EAN
LEDSPL10W	001645	Li 3.7V 4400mAh	10W COB	1000	2-12h	4-5h	8054317736451

Torcia ricaricabile di elevata qualità, perfetta per uso professionale e privato. Grande potenza di illuminazione, illuminazione massima 1000lumen. Dotata di maniglia mobile calamitata.  
*High quality rechargeable flashlight, perfect for professional and private use. Great lighting power, maximum illumination 1000lumen. Equipped with a magnetic mobile handle.*

## SPOTLIGHT 30W

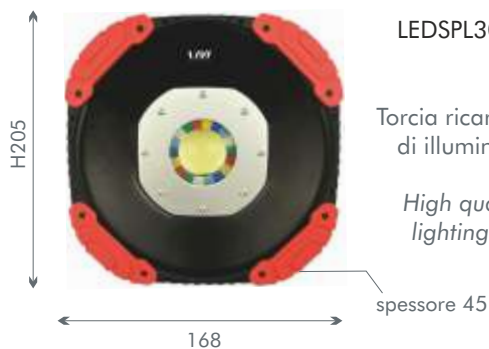

Code	CI	Battery	Led	Lumen	Working Time	Charging Time	EAN
LEDSPL30W	001646	Li 3.7V 14400mAh	30W COB	2500	4-10h	6h	8054317736468

Torcia ricaricabile di elevata qualità, perfetta per uso professionale e privato. Grandissima potenza di illuminazione a 3 step, illuminazione massima 2500 lumen. Dotata di maniglia di appoggio mobile.

*High quality rechargeable flashlight, perfect for professional and private use. Very large 3-step lighting power, maximum illumination 2500 lumens. Equipped with a mobile support handle.*

HOOD TORCH  
TORCIA DA COFANO

Code	CI	Battery	Led	Lumen	Working Time	Charging Time	EAN
TOR41286NL	000230	Li 7.4V 2200mAh	6x 1W	450	3-4h	5h	8053670332300

Torcia a litio ricaricabile, alimentata sia con accendisigari sia a batteria. Luminosità massima di 350 lumen. Lunghezza 1000mm estensibile fino a 1500mm.

*Rechargeable lithium torch, powered by both cigarette lighter and battery. Maximum brightness of 350 lumens. Length 1000mm extendable up to 1500mm.*

## TRAFFIC GUIDE LIGHT



Code	CI	Light Emission	Light Mode	EAN
TORSAFEL5	001652	360°	3 types	8054317736529

Compatta luce LED di emergenza ricaricabile da utilizzare in situazioni di pericolo in strada, ma anche come luce per ispezione. Funzione di emergenza che genera una luce arancione a 360°, visibile da lontano. Lampada molto resistente fino a sopportare il peso di un'auto, con una superficie calamitata. 3 modalità di luce (lampeggiante, fissa oppure come semplice torcia). 2 modalità di funzionamento (in valigetta e singolarmente).

*Compact rechargeable LED emergency light for use in dangerous situations on the road, but also as an inspection light. Emergency function that generates a 360° orange light, visible from far. Very resistant lamp up to supporting the weight of a car, with a magnetized surface. 3 light modes (flashing, steady or as a simple torch). 2 operating modes (in case and individually).*

**BIKE & FREE TIME TORCH Range**

**SPORT LIGHT ARM**

Torcia a pile indossabile o per bici. 3 tipi di illuminazione LED. Cinturino con strap.  
*Wearable or bike torch. 3 types of LED lighting. Strap belt.*



Code	CI	Led	EAN
TORSPORTA	001653	3	8054317736536

**BIKE FRONT LIGHT**

Torcia frontale ricaricabile per bici. 3 tipi diversi di illuminazione a LED. Impermeabile e con cinturino regolabile.  
*Rechargeable headlamp for bikes. 3 different types of LED lighting. Waterproof and with adjustable strap.*



Code	CI	Led	EAN
TORBIKEHL	001654	-	8054317736543

**BIKE REAR LIGHT**

Torcia posteriore ricaricabile per bici. 3 tipi diversi di illuminazione a LED. Impermeabile e con cinturino regolabile.  
*Rechargeable rear torch for bikes. 3 different types of LED lighting. Waterproof and with adjustable strap.*



Code	CI	Led	EAN
TORBIKERL	001655	-	8054317736550

**BIKE KIT**

Kit fronte/retro a pile per bici. 3 diversi tipi di illuminazione led. Colore rosso e bianco.  
*Double-sided battery-powered bike kit. 3 different types of led lighting. Red and white color.*



Code	CI	Led	EAN
TORBIKEKIT	001656	-	8054317736567

**ACCESSORY Range**

**PLUG**



Code	CI	EAN
TORCABPLUG	001402	8054317734020

**SET CHARGE**



Code	CI	EAN
SETCHARGE	001651	8054317736512

**TRIPOD**



Code	CI	EAN
TRIPODSPL	001647	8054317736475
for SPOTLIGHT 30W SPOTLIGHT 10W		



# MINUTERIE

SMALL PARTS

# METAL TIES FASCETTE METALLO

## METAL SCREW TIE FASCETTE IN METALLO A VITE



Code	CI	Size	Thick	Pack	EAN
MT0812S900	000816	Ø8-12	9mm	50pcs	8053670338166
MT1016S900	000817	Ø10-16	9mm	100pcs	8053670338173
MT1222S900	000818	Ø12-22	9mm	100pcs	8053670338180
MT1627S900	000819	Ø16-27	9mm	50pcs	8053670338197
MT2032S900	000820	Ø20-32	9mm	50pcs	8053670338203
MT2540S900	000821	Ø25-40	9mm	50pcs	8053670338210
MT3250S900	000822	Ø32-50	9mm	50pcs	8053670338227
MT4060S900	000823	Ø40-60	9mm	25pcs	8053670338234
MT5070S900	000824	Ø50-70	9mm	25pcs	8053670338241
MT6080S900	000825	Ø60-80	9mm	20pcs	8053670338258
MT7090S900	000826	Ø70-90	9mm	10pcs	8053670338265
MT80100S90	000827	Ø80-100	9mm	10pcs	8053670338272
MT90110S90	000828	Ø90-110	9mm	10pcs	8053670338289
MT100120S9	000829	Ø100-120	9mm	10pcs	8053670338296
MT110130S9	000830	Ø110-130	9mm	10pcs	8053670338302
MT120140S9	000831	Ø120-140	9mm	5pcs	8053670338319
MT130150S9	000832	Ø130-150	9mm	5pcs	8053670338326
MT140160S9	000833	Ø140-160	9mm	5pcs	8053670338333

## MINI METAL SCREW TIE MINI FASCETTE IN METALLO A VITE



Code	CI	Size	Thick	Pack	EAN
MMT0608CS9	000846	Ø6-8	9mm	10pcs	8053670338463
MMT0709CS9	000847	Ø7-9	9mm	10pcs	8053670338470
MMT0810CS9	000848	Ø8-10	9mm	10pcs	8053670338487
MMT0911CS9	000849	Ø9-11	9mm	10pcs	8053670338494
MMT1012CS9	000850	Ø10-12	9mm	10pcs	8053670338500
MMT1113CS9	000851	Ø11-13	9mm	10pcs	8053670338517

## MUFFLER «U» CLAMP FASCETTE IN METALLO TIPO «U»



Code	CI	Size	Thick	Pack	EAN
MCU036CS00	000834	Ø36	7mm	1pc	8053670338340
MCU038CS00	000835	Ø38	7mm	1pc	8053670338357
MCU042CS00	000836	Ø42	7mm	1pc	8053670338364
MCU045CS00	000837	Ø45	7mm	1pc	8053670338371
MCU048CS00	000838	Ø48	7mm	1pc	8053670338388
MCU050CS00	000839	Ø50	7mm	1pc	8053670338395
MCU054CS00	000840	Ø54	7mm	1pc	8053670338401
MCU058CS00	000841	Ø58	7mm	1pc	8053670338418
MCU065CS00	000842	Ø65	7mm	1pc	8053670338425
MCU070CS00	000843	Ø70	7mm	1pc	8053670338432
MCU094CS00	000844	Ø94	7mm	1pc	8053670338449
MCU106CS00	000845	Ø106	7mm	1pc	8053670338456

**METAL JOINT CLAMPS**  
FASCETTE GIUNTI UNIVERSALI



Code	CI	Size	Thick	Pack	EAN
JMT02040MM	001845	Ø20-40	-	10pcs	8054317738455
JMT50120MM	001844	Ø50-120	-	10pcs	8054317738448

**\*CLAMP FOR METAL JOINT CLAMPS**  
PINZA PER FASCETTE GIUNTI UNIV



code: CLAMP00JMT  
CI001846  
EAN: 8054317738462

**METAL SELF-LOCKING JOINTS**  
FASCETTE GIUNTI AUTOBLOCCANTI



Code	CI	Size	Thick	Pack	EAN
JPMT4620MM	001847	4,6x201mm	-	10pcs	8054317738479
JPMT4636MM	001848	4,6x362mm	-	10pcs	8054317738486
JPMT4652MM	001849	4,6x521mm	-	10pcs	8054317738493
JPMT7920MM	001850	7,9x201mm	-	10pcs	8054317738509
JPMT7936MM	001851	7,9x362mm	-	10pcs	8054317738516
JPMT7952MM	001852	7,9x521mm	-	10pcs	8054317738523

**\*CLAMP FOR METAL JOINT CLAMPS**  
PINZA PER FASCETTE GIUNTI UNIV



code: CLAMP0JPMT  
CI001853  
EAN: 8054317738530



# NYLON CABLE TIES

## FASCETTE PLASTICA

### NYLON CABLE TIE FASCETTE IN NYLON



Code	CI	Size	Color	Pack	EAN
25X150BNCT	000366	2,5X150	■ BLACK	100pcs	8053670333666
25X150WNCT	000367	2,5X150	□ WHITE	100pcs	8053670333673
36X140BNCT	000368	3,6X140	■ BLACK	100pcs	8053670333680
36X140WNCT	000369	3,6X140	□ WHITE	100pcs	8053670333697
36X180BNCT	000370	3,6X180	■ BLACK	100pcs	8053670333703
36X180WNCT	000371	3,6X180	□ WHITE	100pcs	8053670333710
48X200BNCT	000372	4,8X200	■ BLACK	100pcs	8053670333727
48X200WNCT	000373	4,8X200	□ WHITE	100pcs	8053670333734
48X280BNCT	000374	4,8X280	■ BLACK	100pcs	8053670333741
48X280WNCT	000375	4,8X280	□ WHITE	100pcs	8053670333758
48X370BNCT	000376	4,8X370	■ BLACK	100pcs	8053670333765
48X370WNCT	000377	4,8X370	□ WHITE	100pcs	8053670333772
76X400BNCT	000378	7,6X400	■ BLACK	100pcs	8053670333789
76X400WNCT	000379	7,6X400	□ WHITE	100pcs	8053670333796

### LOW PROFILE NYLON TIE FASCETTE IN NYLON SENZA INGOMBRO



Code	CI	Size	Color	Pack	EAN
25X110BLPT	000380	2,5X110	■ BLACK	100pcs	8053670333802
25X110WLPT	000381	2,5X110	□ WHITE	100pcs	8053670333819
36X205BLPT	000382	3,6X205	■ BLACK	100pcs	8053670333826
36X205WLPT	000383	3,6X205	□ WHITE	100pcs	8053670333833
46X205BLPT	000384	4,6X205	■ BLACK	100pcs	8053670333840
46X205WLPT	000385	4,6X205	□ WHITE	100pcs	8053670333857
46X370BLPT	000386	4,6X370	■ BLACK	100pcs	8053670333864
46X370WLPT	000387	4,6X370	□ WHITE	100pcs	8053670333871
76X370BLPT	000388	7,6X370	■ BLACK	100pcs	8053670333888
76X370WLPT	000389	7,6X370	□ WHITE	100pcs	8053670333895

# WASHERS *RONDELLE*

## COPPER GASKETS FOR DIESEL INJECTORS RONDELLE RAME RICOTTO PER INIETTORI

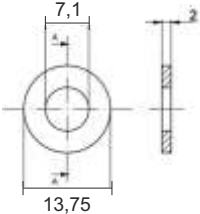
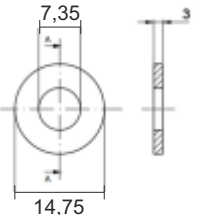
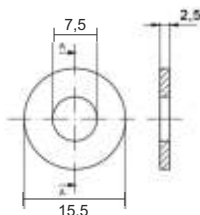
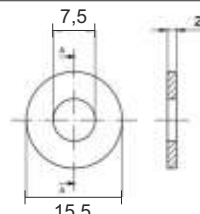
Img	Code	CI	Size	Pack	EAN
	RRI7014200	002247	7,2x13,6x2	10pcs	8051884522470
	RRI7015300	002248	7,2x15x3	10pcs	8051884522487
	RRI7016250	002249	7,5x15,5x2,5	10pcs	8051884522494
	RRI7016200	002250	7,5x16x2	10pcs	8051884522500

## COPPER GASKETS FOR INJECTOR WITH INDENTATIONS RONDELLE RAME PER INIETTORI CON DENTINI

Img	Code	CI	Size	Pack	EAN
	RRIM781515	002251	7x8x15x1,5	10pcs	8051884522517
	RRIM781520	002252	7x8x15x2	10pcs	8051884522524
	RRIM781325	002253	7x8x13x2,5	10pcs	8051884522531

**ASBESTOS FREE ROUNDED COPPER WASHERS RONDELLE RAME BOMBATE ESENTI AMIANTO**

Img	Code	CI	Size	Pack	EAN
	RRSA001420	002254	14x20	50pcs	8051884522548
	RRSA001622	002255	16x22	50pcs	8051884522555
	RRSA001824	002256	18x24	50pcs	8051884522562

**ANNEALED COPPER WASHERS RONDELLE RAME RICOTTO**

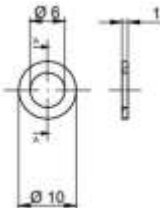
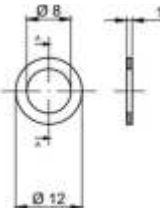
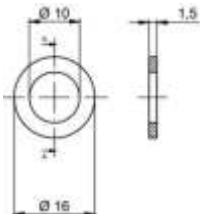
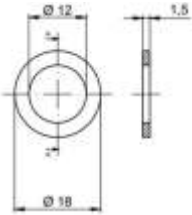
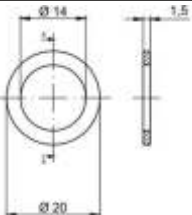
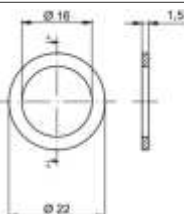
Img	Code	CI	Size	Pack	EAN
	RRR6010100	002266	6x10x1	50pcs	8051884522661
	RRR8012100	002267	8x12x1	50pcs	8051884522678
	RRR1001615	002268	10x16x1,5	50pcs	8051884522685
	RRR1201815	002269	12x18x1,5	50pcs	8051884522692
	RRR1402015	002270	14x20x1,5	50pcs	8051884522708
	RRR1602215	002271	16x22x1,5	50pcs	8051884522715

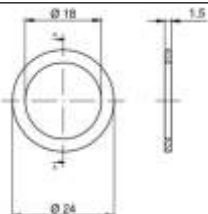
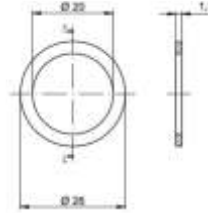
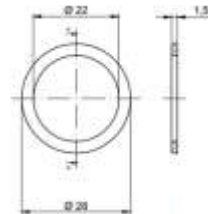
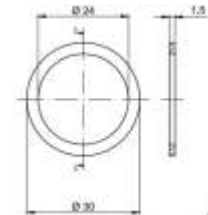
Img	Code	CI	Size	Pack	EAN
	RRR1802415	002272	18x24x1,5	50pcs	8051884522722
	RRR2002615	002273	20x26x1,5	50pcs	8051884522739
	RRR2202815	002274	22x28x1,5	50pcs	8051884522746
	RRR2403015	002275	24x30x1,5	50pcs	8051884522760

SOFT ALUMINIUM WASHERS RONDELLE ALLUMINIO COTTO

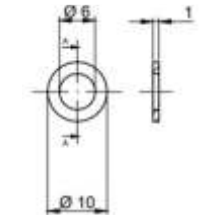
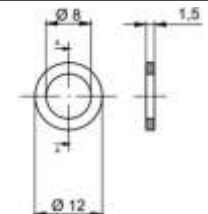
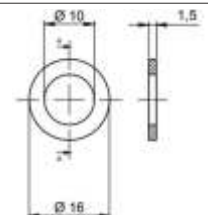
Img	Code	CI	Size	Pack	EAN
	RAC6010100	002257	6x10x1	50pcs	8051884522579
	RAC8012150	002258	8x12x1,5	50pcs	8051884522586
	RAC1001615	002259	10x16x1,5	50pcs	8051884522593

## WASHERS Range

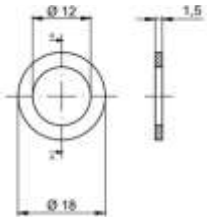
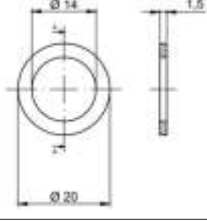
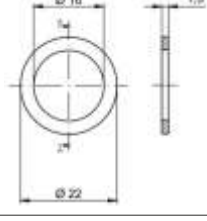
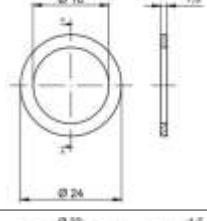
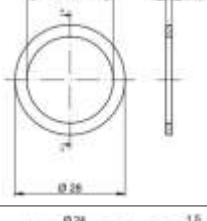
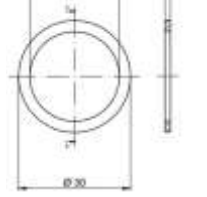
Img	Code	CI	Size	Pack	EAN
	RAC1201815	002260	12x18x1,5	50pcs	8051884522609
	RAC1402015	002261	14x20x1,5	50pcs	8051884522616
	RAC1602215	002262	16x22x1,5	50pcs	8051884522623
	RAC1802415	002263	18x24x1,5	50pcs	8051884522630
	RAC2202815	002264	22x28x1,5	50pcs	8051884522647
	RAC2403015	002265	24x30x1,5	50pcs	8051884522654

## ASSORTMENT CASE 400PZ COPPER VALIGETTA ASSORTIMENTO 400PZ RAME



code: RRRASS0400  
CI002275  
EAN: 8051884522753

Size	Quantity
6x10x1	50
6x12x1	50
8x12x1	50
8x14x1	50
10x14x1	50
10x14x1.5	25
10x16x1.5	25
12x16x1.5	14

Size	Quantity
12x18x1.5	13
13x18x1.5	13
14x20x1.5	10
16x22x1.5	10
17x22x1.5	10
18x24x1.5	10
20x26x1.5	10
22x28x1.5	10





**DIESEL**

# TUBI PER FLUIDI

**FLUIDS HOSES**

# FUEL HOSES

## TUBI CARBURANTE TESSUTO INTERNO



Tubi carburante in neoprene NBR/CR con inserto in tessuto interno. Adatto alla conduzione di benzina super e senza piombo. Fornito in bobina da 10 metri.  
*NBR / CR neoprene fuel hoses with internal fabric insert. Suitable for running premium and unleaded petrol. Supplied in a 10 mt reel.*

Code	CI	Internal Ø	Outer Ø	Thickness	Work Pressure	Max Pressure	Min bending radius	Reel Length	EAN
FP4X950010	002444	4mm	9,5mm	2,8mm	10 bar	30 bar	50mm	10mt	8051884524443
FP5X110010	002445	5mm	11mm	3mm	10 bar	30 bar	55mm	10mt	8051884524450
FP6X120010	002446	6mm	12mm	3mm	10 bar	30 bar	60mm	10mt	8051884524467
FP7X120010	002447	7mm	12mm	3,5mm	10 bar	30 bar	90mm	10mt	8051884524474
FP75X13510	002448	7,5mm	13,5mm	3mm	10 bar	30 bar	75mm	10mt	8051884524481
FP10X17010	002449	10mm	17mm	3,5mm	10 bar	30 bar	90mm	10mt	8051884524498
FP12X18010	002450	12mm	18mm	3mm	10 bar	30 bar	115mm	10mt	8051884524504

# FUEL HOSES TEXTILE TUBI

## CARBURANTE TRECCIA TESSUTO ESTERNO



Tubi carburante in gomma nitrilica con treccia in tessuto esterna. Adatto alla conduzione di benzina super e gasolio. Fornito in bobina da 10 metri.  
*Nitrile rubber fuel hoses with external fabric braid. Suitable for running super petrol and diesel. Supplied in a 10 mt reel.*

Code	CI	Internal Ø	Outer Ø	Thickness	Work Pressure	Max Pressure	Min bending radius	Reel Length	EAN
FPT32X7010	002451	3,2mm	7mm	1,9mm	10 bar	30 bar	40mm	10mt	8051884524511

# WATER HOSES

## TUBI ACQUA RINFORZATI



Tubo per acqua in EPDM/EPDM con inserto in tessuto interno. Adatto al passaggio di acqua o liquido refrigerante fino a 120°C. Fornito in bobina da 15 metri.

*EPDM / EPDM water hose with internal fabric insert. Suitable for the passage of water or coolant up to 120 ° C. Supplied in a 15 mt reel.*



Code	CI	Internal Ø	Outer Ø	Thickness	Work Pressure	Max Pressure	Min bending radius	Reel Length	EAN
WHT8X15007	002452	8mm	15mm	3,5mm	7 bar	14 bar	---	15mt	8051884524528
WHT10X1707	002453	10mm	17mm	3,5mm	7 bar	14 bar	---	15mt	8051884524535
WHT12X1907	002454	12mm	19mm	3,5mm	7 bar	14 bar	---	15mt	8051884524542
WHT15X2107	002455	15mm	21mm	3mm	7 bar	14 bar	---	15mt	8051884524559
WHT16X2407	002456	16mm	24mm	4mm	7 bar	14 bar	---	15mt	8051884524566
WHT19X2707	002457	19mm	27mm	4mm	7 bar	14 bar	---	15mt	8051884524573
WHT22X2807	002458	22mm	28mm	---	7 bar	14 bar	---	15mt	8051884524580

# PVC HOSES

## TUBI PVC



Code	CI	Internal Ø	Outer Ø	Thickness	Work Pressure	Max Pressure	Min bending radius	Reel Length	EAN
PVCH3X6010	002459	3mm	6mm	1,5mm	10 bar	10 bar	---	10mt	8051884524597
PVCH5X9010	002460	5mm	9mm	1,5mm	10 bar	10 bar	---	10mt	8051884524603
PVCH7X1210	002461	7mm	12mm	1,5mm	10 bar	10 bar	---	10mt	8051884524610



# INGRASSATORI E ACCESSORI

GREASE ELEMENTS

# GREASE ELEMENTS

## INGRASSATORI TESTINE ACCESSORI

### GREASER/INGRASSATORE

#### GREASE GUN / PISTOLA MANUALE



Code	CI	Material	Packing	EAN
GREASGUN01	001783	Metal	1pc	8054317737830

### ACCESSORY/ACCESSORI

#### FLEXIBLE TUBE TUBO FLESSIBILE



Code	CI	Material	Packing	EAN
GREASTUB01	001785	Nylon+ Metal	1pc	8054317737854

#### GREASE HEAD TESTINA 4 GRIFFE



Code	CI	Material	Packing	EAN
GREASOHEAD	001784	Metal	1pc	8054317737847

### HEADS/TESTINE

#### M6X1-0



Code	CI	Head	Angle	M	EAN
GREAS06100	001774	ROUND	0°	6x1mm	8054317737748

#### M6X1-45



Code	CI	Head	Angle	M	EAN
GREAS06145	001775	ROUND	45°	6x1mm	8054317737755

#### M6X1-90



Code	CI	Head	Angle	M	EAN
GREAS06190	001776	ROUND	90°	6x1mm	8054317737762

#### M8X1-0



Code	CI	Head	Angle	M	EAN
GREAS08100	001777	ROUND	0°	8x1mm	8054317737779

#### M8X1-45



Code	CI	Head	Angle	M	EAN
GREAS08145	001778	ROUND	45°	8x1mm	8054317737786



## GREASE HEADS Range

**M8X1-90**



Code	CI	Head	Angle	M	EAN
GREAS08190	001779	ROUND	90°	8x1mm	8054317737793

**M10X1-0**



Code	CI	Head	Angle	M	EAN
GREAS01010	001780	ROUND	0°	10x1mm	8054317737809

**M10X1-45**



Code	CI	Head	Angle	M	EAN
GREAS01045	001781	ROUND	45°	10x1mm	8054317737816

**M10X1-90**



Code	CI	Head	Angle	M	EAN
GREAS01019	001782	ROUND	90°	10x1mm	8054317737823



**ACCESSORI PER ARIA  
COMPRESSA  
& GONFIATORI GOMME**  
**COMPRESSED AIR ACCESSORY & TYRE INFLATORS**

# GUNS & ACCESSORIES

## PISTOLE E ACCESSORI

### BLOW GUN

PISTOLA CON FILO



Code	CI	Material	EAN
AIRBGUN002	001773	Steel	8054317737731

### INFLATING GUN

PISTOLA + MANOMETRO INTEGRATO



Code	CI	Material	EAN
AIRIGUN023	001772	Steel	8054317737724

### AIR PUMP FITTING

ATTACCO ARIA



Code	CI	Material	EAN
AIRPFIT027	001770	Steel	8054317737700

### VALVE CAPS

TAPPO



Code	CI	Material	EAN
AIRVCAP014	001771	Steel	8054317737717

# TYRE INFLATOR

## GONFIA E RIPARA GOMME

### TYRE INFLATES AND REPAIRS

GONFIA E RIPARA GOMME



Code	CI	Description	EAN
<b>AIRKTIRE01</b>	<b>001841</b>	<b>KIT: Sealant+ Compressor</b>	<b>8054317738417</b>
AIRSEA0001	001842	<u>only Sealant</u> <u>refill</u> Ricarica sigillante	8054317738424
AIRCOMP001	001843	<u>only</u> <u>Compressor</u> <u>Compressore</u>	8054317738431



# PILE DURACELL







## DURACELL BATTERIES

# CELLS & BATTERIES

## PILE E BATTERIE

IMG	Code	CI	Form	Type	Pack	EAN
	DUR0CR1220	002282	CR1220	LITIO 3V	1pc	8051884522821
	DUR0CR1616	002283	CR1616	LITIO 3V	1pc	8051884522838
	DUR0CR1620	002284	CR1620	LITIO 3V	1pc	8051884522845
	DUR0CR1632	002285	CR1632	LITIO 3V	1pc	8051884522852
	DUR0CR2016	002286	CR2016	LITIO 3V	2pcs	8051884522869
	DUR0CR2025	002287	CR2025	LITIO 3V	2pcs	8051884522876
	DUR0CR2032	002288	CR2032	LITIO 3V	2pcs	8051884522883
	DUR0CR2430	002289	CR2430	LITIO 3V	1pc	8051884522890
	DUR0CR2450	002290	CR2450	LITIO 3V	1pc	8051884522906
	DUR000LR43	002291	LR43	ALCAL. 1.5V	2pcs	8051884522913
	DUR000LR44	002292	LR44	ALCAL. 1.5V	2pcs	8051884522920
	DUR000LR54	002293	LR54	ALCAL. 1.5V	2pcs	8051884522937
	DUR000MN21	002294	MN21	ALCAL. 12V	2pcs	8051884522944



IMG	Code	CI	Form	Type	Pack	EAN
	DUR0MN9100	002295	MN9100	ALCAL. 1.5V	2pcs	8051884522951
	DUR000MN27	002296	MN27	ALCAL. 12V	1pc	8051884522968
	DUR00AALR6	002297	AA PLUS	ALCAL. 1.5V	4pcs	8051884522975
	DURAAALR03	002298	AAA PLUS	ALCAL. 1.5V	4pcs	8051884522982
	DUR00DLR20	002299	D PLUS	ALCAL. 9V	2pcs	8051884522999
	DUR9V6LR61	002300	9V PLUS	ALCAL.	1pc	8051884523002



# PRODOTTI SERVICE

SERVICE PRODUCTS

# PAPER REELS *BOBINE DI CARTA*

## STANDARD 800

CARTA STANDARD 800



Code	CI	Lenght	Tears	Veils	Pack	EAN
CARTSTD800	001839	184mt	800	2	2	8054317738394

\*pallet composto da 35 coppie

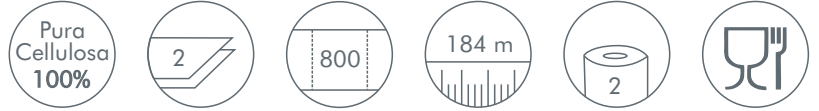

## PROFESSIONAL 800

CARTA PROFESSIONAL 800



Code	CI	Lenght	Tears	Veils	Pack	EAN
CARTPRO800	001840	296mt	800	2	2	8054317738400

\*pallet composto da 28 coppie



# HAND WASHING *LAVAMANI*

## PASTA 4KG



Code	CI	Colour	Weight	Pack	EAN
PASTA04WHI	001961	White	4kg	4	8054317739612

## CREAM BLUE



Code	CI	Colour	Weight	Pack	EAN
CREAM04BLU	001960	Blue	4kg	2	8054317739605

# DISPOSABLE GLOVES

## GUANTI MONOUSO

**BLUE NITRILE 4,8gr**  
**GUANTI MONOUSO NITRILE**  
**MASSIMA RESISTENZA 4,8gr**



Code	CI	Size	Weight	Gloves/Dispenser	Dispenser/Carton	EAN
GBLU00S100	002433	S 6-6,5	4,8g	100	10	8051884524337
GBLU00M100	002434	M 7-7,5	4,8g	100	10	8051884524344
GBLU00L100	002435	L 8-8,5	4,8g	100	10	8051884524351
GBLU00XL100	002436	XL 9-9,5	4,8g	100	10	8051884524368

**DPI Cat. I - solo per rischi minimi** Conformità EN ISO 21420:2020  
**PPE Cat. I - for minimal risks only** Compliance with standards EN ISO 21420:2020

**Non sterili Non-sterile**  
**Ambidestri Ambidextrous**  
**Polpastrelli texturizzati Textured fingertips**  
**Monouso Single use only**  
**Senza lattice No latex**

**ORANGE NITRILE 8,6gr**  
**GUANTI MONOUSO NITRILE**  
**SPESSORE EXTRA 8,6gr**



Code	CI	Size	Weight	Gloves/Dispenser	Dispenser/Carton	EAN
GORN00S050	002277	S 6-6,5	8,6g	50	10	8051884522777
GORN00M050	002278	M 7-7,5	8,6g	50	10	8051884522784
GORN00L050	002279	L 8-8,5	8,6g	50	10	8051884522791
GORN00XL050	002280	XL 9-9,5	8,6g	50	10	8051884522807
GORNXXL050	002281	XXL 10-10,5	8,6g	50	10	8051884522814

**DPI Cat. I - solo per rischi minimi** Conformità EN 420:2009+A1:2009  
**PPE Cat. I - for minimal risks only** Compliance with standards EN 420:2003+A1:2009

**Spessore Extra Extra Thick**  
**Non sterili Non-sterile**  
**Ambidestri Ambidextrous**  
**Superficie texturizzata Textured grip surface**  
**Monouso Single use only**  
**Senza lattice No latex**



# FABRIC GLOVES

## GUANTI TESSUTO

### POLYURETHANE TEXTURE/TEXTURE POLIURETANO

#### STANDARD

#### GUANTI STANDARD SPALMATI IN POLIURETANO



**DPI Cat. II** - Conformità EN 388  
**PPE Cat. II** - Compliance with standards EN 388



Code	CI	Size	Pack	Pair/ Inner	EAN
GTSDP00M02	000346	M 7-7,5	1pair	12	8053670333468
GTSDP00L02	000347	L 8-8,5	1pair	12	8053670333475
GTSDP0XL02	000348	XL 9-9,5	1pair	12	8053670333482
GTSDPXXL02	000349	XXL 10-10,5	1pair	12	8053670333499

**Spalmato Polyurethane Coated**  
**Non sterili Non-sterile**  
**Destro-Sinistro Right-Left**  
**Polsino in tessuto Cuff Fabric**  
**Palmo ricoperto Coated Palm**

#### POLITEX

#### GUANTI SPALMATI IN POLIURETANO ULTRALEGGERI



**DPI Cat. II** - Conformità EN 388  
**PPE Cat. II** - Compliance with standards EN 388



Code	CI	Size	Pack	Pair/ Inner	EAN
GTNJP00M02	000350	M 7-7,5	1pair	12	8053670333505
GTNJP00L02	000351	L 8-8,5	1pair	12	8053670333512
GTNJP0XL02	000352	XL 9-9,5	1pair	12	8053670333529
GTNJPXXL02	000353	XXL 10-10,5	1pair	12	8053670333536

**Spalmato Polyurethane Coated**  
**Non sterili Non-sterile**  
**Destro-Sinistro Right-Left**  
**Polsino in tessuto Cuff Fabric**  
**Palmo ricoperto Coated Palm**



NITRILE TEXTURE/TEXTURE NITRILE

**SOFT FOAM**  
GUANTI SPALMATI IN NITRILE  
CON SCHIUMA MORBIDA



**DPI Cat. II** - Conformità EN 388  
**PPE Cat. II** - Compliance with standards EN 388



Code	CI	Size	Pack	Pair/ Inner	EAN
GTSFN00M02	000354	M 7-7,5	1pair	12	8053670333543
GTSFN00L02	000355	L 8-8,5	1pair	12	8053670333550
GTSFN0XL02	000356	XL 9-9,5	1pair	12	8053670333567
GTSFNXXL02	000357	XXL 10-10,5	1pair	12	8053670333574

**Spalmato Nitrile Coated**  
**Non sterili Non-sterile**  
**Destro-Sinistro Right-Left**  
**Polsino in tessuto Cuff Fabric**  
**Palmo ricoperto in schiuma morbida Soft foam coating palm**

**3/4**  
GUANTI SPALMATI IN NITRILE CON  
COPERTURA 3/4 PALMO E DORSO



**DPI Cat. II** - Conformità EN 388  
**PPE Cat. II** - Compliance with standards EN 388



Code	CI	Size	Pack	Pair/ Inner	EAN
GT34N00M02	000358	M 7-7,5	1pair	12	8053670333581
GT34N00L02	000359	L 8-8,5	1pair	12	8053670333598
GT34N0XL02	000360	XL 9-9,5	1pair	12	8053670333604
GT34NXXL02	000361	XXL 10-10,5	1pair	12	8053670333611

**Spalmato Nitrile Coated**  
**Non sterili Non-sterile**  
**Destro-Sinistro Right-Left**  
**Polsino in tessuto Cuff Fabric**  
**Copertura 3/4 palmo e dorso**  
**3/4 coating palm and back**

# ADHESIVE TAPES *NASTRI ADESIVI*

## INSULATING TAPE/*NASTRO ISOLANTE*

**INSULATING BLACK**  
ISOLANTE NERO



Code	CI	Measure	Pack	EAN
GK17000-28	002302	mm15x10mt	10pcs TOWER	8051884523026

**INSULATING COLOUR MIX**  
ISOLANTE MIX COLORI



Code	CI	Measure	Pack	EAN
GK17000-17	002301	mm15x10mt	10pcs TOWER	8051884523019

## AMERICAN TAPE/*NASTRO AMERICANO*

**SILVER CANVAS**  
TELATO ARGENTO



Code	CI	Measure	Pack	EAN
GK19100-1	002303	mm50x25mt	1pc	8051884523033

**BLACK CANVAS**  
TELATO NERO



Code	CI	Measure	Pack	EAN
GK19100-2	002304	mm50x25mt	1pc	8051884523040

**RED/WHITE**  
BIANCO/ROSSO



Code	CI	Measure	Pack	EAN
GK18040-2	002316	mm50x25mt	1pc	8051884523163

**YELLOW/BLACK**  
GIALLO/NERO



Code	CI	Measure	Pack	EAN
GK18040-1	002317	mm50x25mt	1pc	8051884523170

## PAPER TAPE/*NASTRO CARTA*

**PAPER 50x25**  
CARTA 50x25



Code	CI	Measure	Pack	EAN
GK21000-219	002305	mm25x50mt	1pc	8051884523057

**PAPER 50x50**  
CARTA 50x50



Code	CI	Measure	Pack	EAN
GK21000-225	002306	mm50x50mt	1pc	8051884523064

**PACK NOISE TAPE/NASTRO PACCHI**

**PACK NOISE HAVANA**  
PACCHI AVANA



Code	CI	Measure	Pack	EAN
GK18000-50	002307	mm50x66y	6pcs TOWER	8051884523071

**PACK NOISE CLEAR**  
PACCHI TRASPARENTE



Code	CI	Measure	Pack	EAN
GK18000-52	002308	mm50x66y	6pcs TOWER	8051884523088

**NON-SLIP TAPE/NASTRO ANTISCIVOLO**

**NON-SLIP Y/B**  
ANTISCIVOLO G/N



Code	CI	Measure	Pack	EAN
GK220-23	002309	mm25x18mt	1pc	8051884523095

**NON-SLIP BLACK**  
ANTISCIVOLO NERO



Code	CI	Measure	Pack	EAN
GK220-20	002310	mm25x18mt	1pc	8051884523101

**REFLECTIVE/NASTRO RIFLETTENTE**

**REFLECTIVE +  
FLUORESCENT**  
RIFLETTENTE+  
FLUORESCENTE



Code	CI	Measure	Pack	EAN
GK31500-1	002311	mm19x2,5mt	1pc	8051884523118

**DOUBLE SIDED/NASTRO BIADESIVO**

**DOUBLE-SIDE POLYP**  
BIADESIVO POLYP



Code	CI	Measure	Pack	EAN
GK22020-10	002312	mm50x5mt	1pc	8051884523125

**DOUBLE-SIDE CLEAR**  
BIADESIVO  
TRASPARENTE



Code	CI	Measure	Pack	EAN
GK20010	002313	mm19x1,5mt	1pc	8051884523132

**SELF-AGGLOMERATING/NASTRO AUTOAGGLOMERANTE**

**SELF-AGGLOMERATING**  
AUTOAGGLOMERANTE



Code	CI	Measure	Pack	EAN
GK16000	002314	mm25x3mt	1pc	8051884523149

## SILICONE TAPE/NASTRO AL SILICONE

**SILICONE HT**  
SILICONE ALTE TEMP



Code	CI	Measure	Pack	EAN
GK42000-1	002315	mm25x3mt	1pc	8051884523156

## SHOCKPROOF ADHESIVE PANELS/PANNELLI ADESIVI ANTIURTO

**LARGE MEASURE**  
MISURA GRANDE



Code	CI	Measure	Pack	EAN
GK1810-05	002318	24x50cm	2pcs in POLYBAG	8051884523187

**STANDARD MEASURE**  
MISURA STANDARD



Code	CI	Measure	Pack	EAN
GK1810	002319	13,7x50cm	2pcs in POLYBAG	8051884523194

**JOLLY MEDIUM**  
MEDIO JOLLY



Code	CI	Measure	Pack	EAN
GK1810-01	002320	32x40cm	1pc in POLYBAG	8051884523200

## STRETCH FILM + DISTRIBUTOR/FILM E DISTRIBUTORE

**STRETCH FILM 125MM**  
FILM 125MM



Code	CI	Measure	Pack	EAN
GK7300-4	002328	125mm 23my	1pc	8051884523286

**FILM DISTRIBUTOR 125MM**  
DISTRIBUTORE FILM 125MM



Code	CI	Measure	Pack	EAN
GK7300-29	002329	---	1pc	8051884523293



# TECHNICAL FLUIDS

LIQUIDI TECNICI



# ANTIFREEZING *ANTIGELO MOTORE*

## COOLRED ROSSO CONCENTRATO



Code	CI	Content	Pack	EAN
COOLRED001	001978	1lt	12pcs/ carton	8054317739780
COOLRED020	001979	20kg	1pc	8054317739797

## COOLBLUE BLU CONCENTRATO



Code	CI	Content	Pack	EAN
COOLBLUE01	001981	1lt	12pcs/ carton	8054317739810
COOLBLUE20	001982	20kg	1pc	8054317739827

## COOLPRP VIOLA CONCENTRATO



Code	CI	Content	Pack	EAN
COOLPRP001	002462	1lt	12pcs/ carton	8051884524627

# CHEMICAL WINDSHIELD

## CHIMICO PARABREZZA

### SUMMER WASHING CLEANER

LAVAVETRI ESTIVO  
CONCENTRATO  
PARABREZZA



Code	CI	Content	Pack	EAN
LVE00CL25	000048	250ml	50pcs/ carton	8053670330498
LVECL5000	002463	5000ml	1pc	8051884524634

Prodotto apposito per impianti lavavetri e lavafari. Deterge il parabrezza rimuovendo ogni tipo di sporco, polvere e smog, zero aloni e rispetta la verniciatura, le parti in gomma e in alluminio.

Product suitable for windshield washer systems and headlamp washers. Cleans the windshield removing all kinds of dirt, dust and smog, zero stains and respects the paint, rubber and aluminium parts.

\*le immagini sono puramente indicative the images are purely indicative

### WINTER WASHING CLEANER

LAVAVETRI INVERNALE -70°C  
PARABREZZA



Code	CI	Content	Pack	EAN
LVI65CL25	000047	250ml	12pcs/ carton	8053670330481
LVICL5000	002464	5000ml	1pc	8051884524641

Prodotto apposito per impianti lavavetri e lavafari che assicura ottima protezione dal gelo. Deterge il parabrezza rimuovendo ogni tipo di sporco, polvere e smog, non lascia aloni e rispetta la verniciatura, le parti in gomma e in alluminio.

Product suitable for windshield washer systems and headlamp washers that provides excellent protection against frost. Cleans the windshield removing all kinds of dirt, dust and smog, not leave stains and respects the paint, rubber parts and aluminium.

\*le immagini sono puramente indicative the images are purely indicative

ICE ZERO  
DEGHIACCIANTE  
PARABREZZA



Code	CI	Content	Pack	EAN
IZE00CL20	000049	200ml	24pcs/ carton	8053670330504

Elimina velocemente lo strato di gelo che si forma sul parabrezza nel periodo invernale. Svolge anche una buona azione detergente.

Quickly remove the layer of frost in winter season. Good cleaning action.

TOP VISION  
WASHING FOAM  
SCHIUMA DETERGENTE



Code	CI	Content	Pack	EAN
TVI00CL40	000050	250ml	12pcs/ carton	8053670330511

Schiuma detergente appositamente formulata per superfici in vetro, cristalli, similpelle, plastica, legno, gomma e metallo. Rimuove con facilità polvere, sporco, smog e aloni.

Foam cleaner specially formulated for glass, crystal, leather, plastic, wood, rubber and metal. Easily removes dust, dirt, smog and stains.

# BRAKE FLUIDS *LIQUIDI FRENI*

## BRAKE FLUID DOT4 OLIO FRENI



Code	CI	Content	Pack	EAN
DOT40001	002465	1lt	-	8051884524658

## BRAKE CLEANER PULITORE FRENI



Code	CI	Content	Pack	EAN
BRC000500	002466	1lt	-	8051884524665

# *ADBLUE*



Code	CI	Content	Pack	EAN
ADBLUE0010	002467	10lt	1pc	8051884524672
ADBLUE0200	002468	200lt	1pc	8051884524689
ADBLUE1000	002469	1000lt	1pc	8051884524696



**POLARITA'/POLARITY**

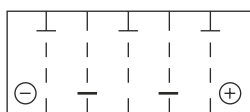

0(DX)

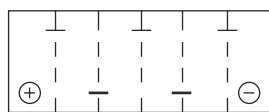

1(SX)

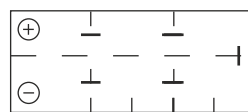

3(SX)

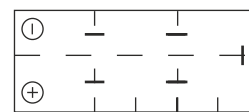

4(DX)

**TERMINALE/TERMINAL**

**GRANDI / BIG**

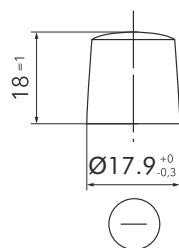
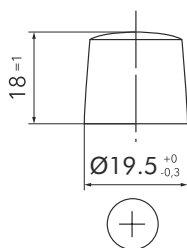

**PICCOLI / SMALL**

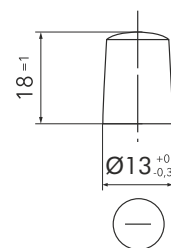
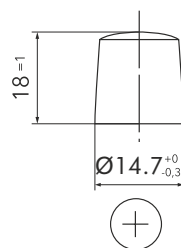

**FISSAGGIO ALLA BASE/FIXING BASE**

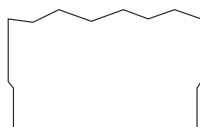
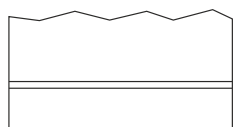

B00

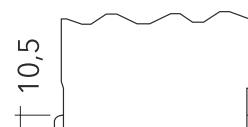
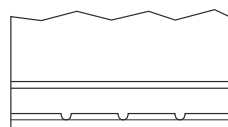

B01

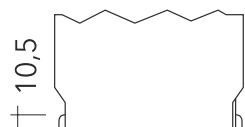
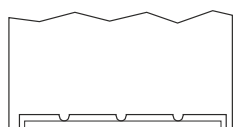

B01  
INT

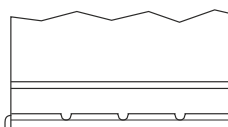

B03

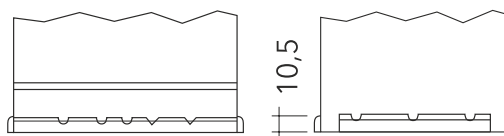

B13









